

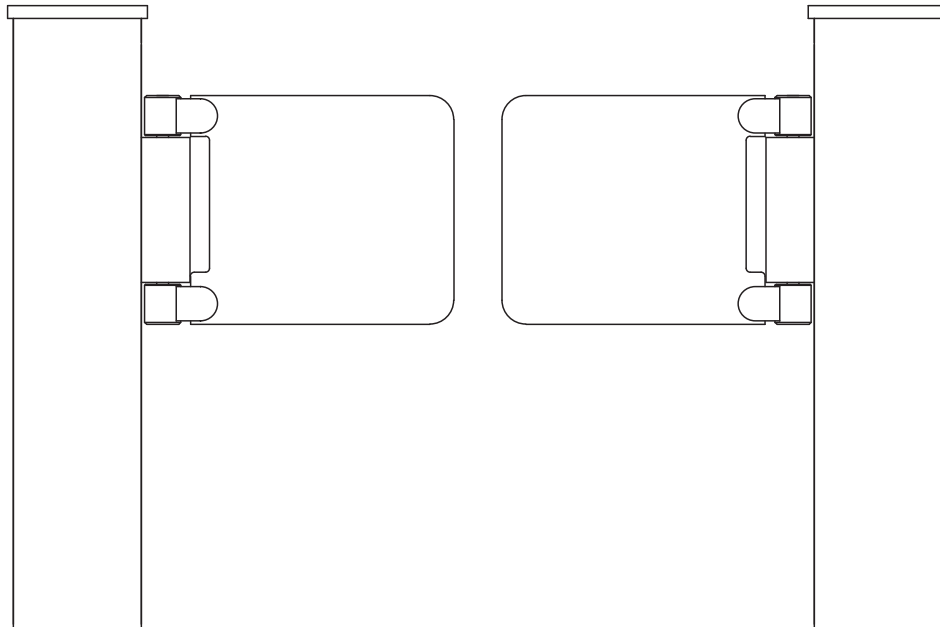

Executive Series EX300

Barrier Optical Swing Gate Lane

Service & Installation Manual





Theory of Operation	3
Lane Functionality	4
Pre-installation Tips	6
Installation Instructions	7
Concrete Anchor Information	9
Installation Instructions	10
Sensor Alignment	11
Sensor Designations	12
Wiring Introduction	13
Wiring Legend	14
Access Control & Indication Wiring	15
ADA Secondary Cabinet Wiring	16
Primary Cabinet Motion Control Wiring	17
Primary Cabinet Optical Sensor Wiring	18
Primary Cabinet Interconnection Wiring	19
EX300 Settings & Statistics	20
Warranty	25

EX300 Barrier Optical Turnstile

Theory of Operation:

The EX300 barrier optical swing gate lane is designed to control traffic with an intuitive motorized barrier design. This is accomplished with thru-beam type sensors to detect where a person is inside of the lane. Crossing and uncrossing certain beams at certain times will evaluate a passage to be either authorized or unauthorized.

Within each lane there are two primary zones of sensors. Each zone acts as a “limit”. Upon a valid entry (card read, push button, keypad, etc.), the unit recognizes authorization and swings open to allow passage through in the direction requested. Once passage is complete, the arms return to their home position.

Should a user pass in the incorrect direction or has not been authorized for passage, an audible alarm will pulse and red LEDs will flash. An additional solid state output during alarm scenarios also exists for integration into other security systems.

In addition to the two sensor zones mentioned previously, a third sensor zone exists for crawl-through detection. If anyone attempts to crawl through the lane under the arms, the third sensor zone detects them and an alarm goes off.

EX300 lanes are designed to allow heavy flows of traffic. With an adjustable swipe queue, one user can request passage through the lane while another is already inside. This negates the need to wait for the lane to return to a secured status before the next person can pass.

Physically, a lane of EX300 consists of two cabinets: a primary and a secondary. From this base pair, additional single arm lanes can be added. This is accomplished by changing the rear of the cabinet to accept transmitter sensors for the next primary cabinet to create a lane.

Inside the primary cabinet, a logic controller with a display screen and input buttons allow a variety of settings for the machine to be adjusted to facility preferences.

Lane Functionality

Lane configuration:

Each base lane consists of two different types of cabinets; a primary cabinet and a secondary cabinet. In instances where additional single arm lanes are added to an array, the rear side of each cabinet opposite of the lane's cabinet with the arm becomes a secondary panel to the primary cabinet of that lane. See sample layout below.

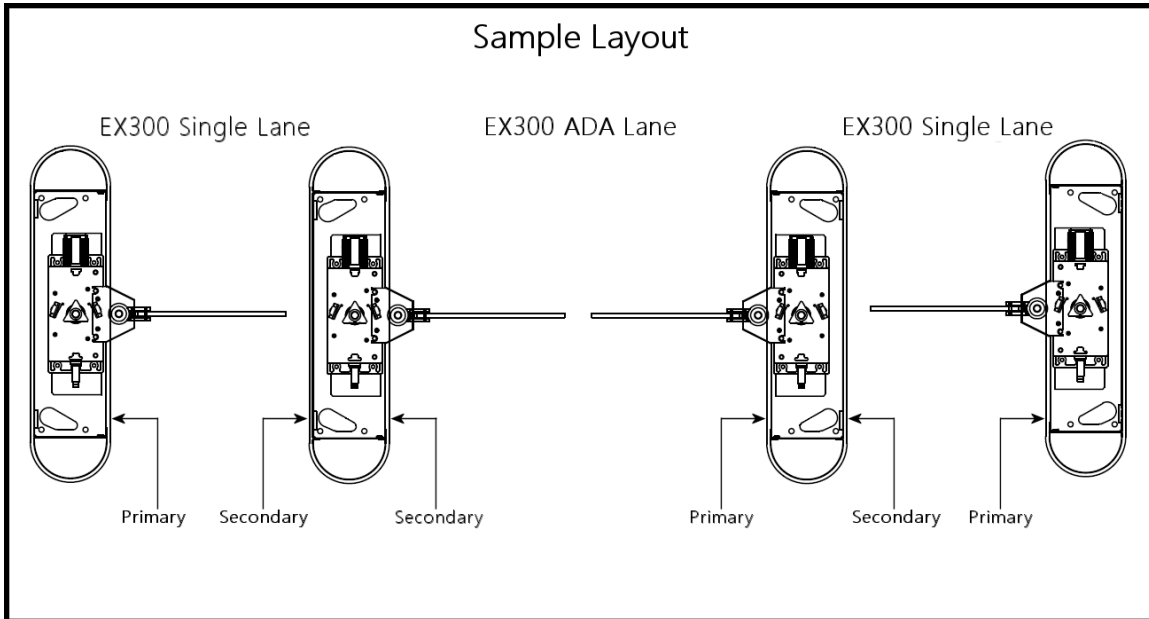

The base ADA lane's secondary cabinet communicates with the primary cabinet with a provided 12 conductor cable. This allows the primary cabinet to operate the solenoids and motor of the secondary cabinet, as well as keep track of the secondary cabinet's arm position via its 3 proximity sensors.

The secondary cabinet also contains 7 optical transmitters which the primary cabinet uses to evaluate lane passage via receivers. This is also applicable for each single arm lane within an array.

From the factory, each cabinet in an array is preconfigured to the requested operation and layout. Each lane has two directions of passage, each of which can be configured for controlled passage, free passage or no passage. This configuration can be changed in the field via settings on lane's logic controller located inside of the primary cabinet.

Lane Functionality (cont.)

Electrical requirements:

Primary cabinets require 100-240 VAC input voltage. An internal power supply steps the voltage down to 24VDC.

Between the two cabinets in an ADA lane, an 18 gauge 12 conductor cable is necessary in order to operate the secondary cabinet. It will be necessary to provide 3/4" conduit access between the two cabinets. However, only the primary cabinet requires 100-240VAC. The secondary cabinet will obtain 24VDC from the primary cabinet.

The secondary panel (rear of the cabinet across from the primary cabinet) of a single arm lane is powered with only a 2 conductor cable from the primary cabinet, as there are no solenoids, motors or proximity sensors involved in that instance. This cable provides voltage to the optical transmitters for that lane.

It is recommended that the primary side of a hybrid cabinet receives 100-240VAC and the secondary side receives the 24VDC from the primary cabinet of the other lane. This is so one lane can be taken offline without affecting the next one.

The primary cabinet may also require conduit access from the access control system, this is dependent on the method of installation of access control.

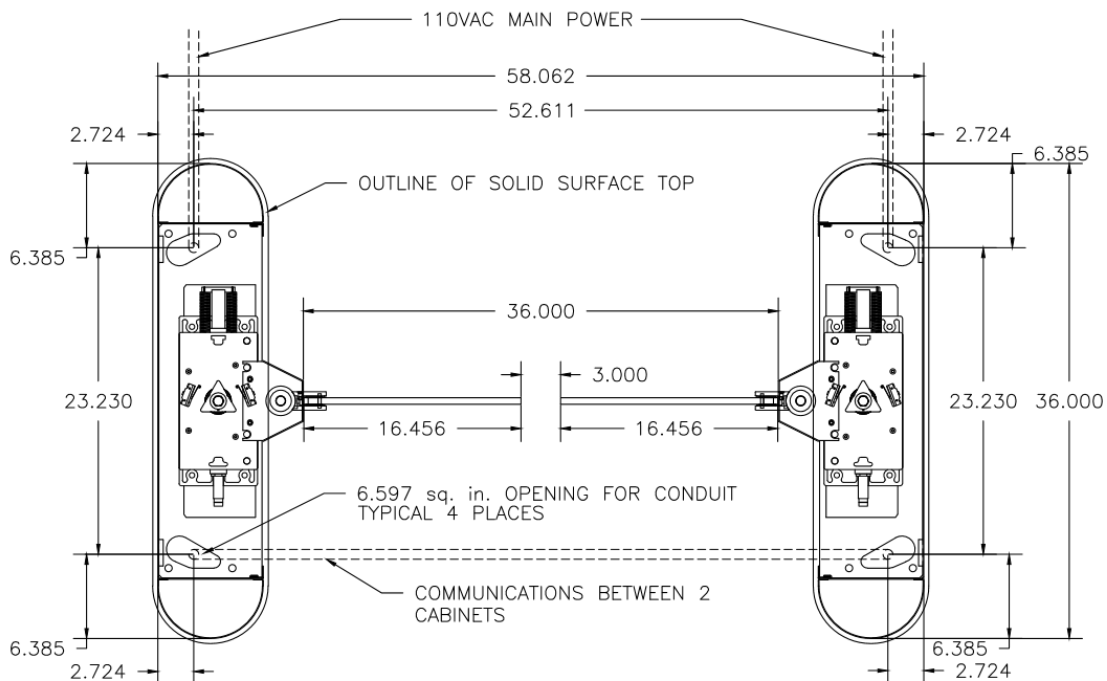

Pre-installation Preparation

In order to install an EX300 lane, each cabinet needs to be opened up. Once opened, anchor holes for concrete mounting as well as conduit access for electrical work can be accessed. Each cabinet has two removable front panels and a lid that need to be removed in order to install.

The first front panel to remove is a V-shaped cover which is fastened onto an aluminum housing for the arm assembly. It is held into place with two 10-24 stainless steel button heads (shown below).

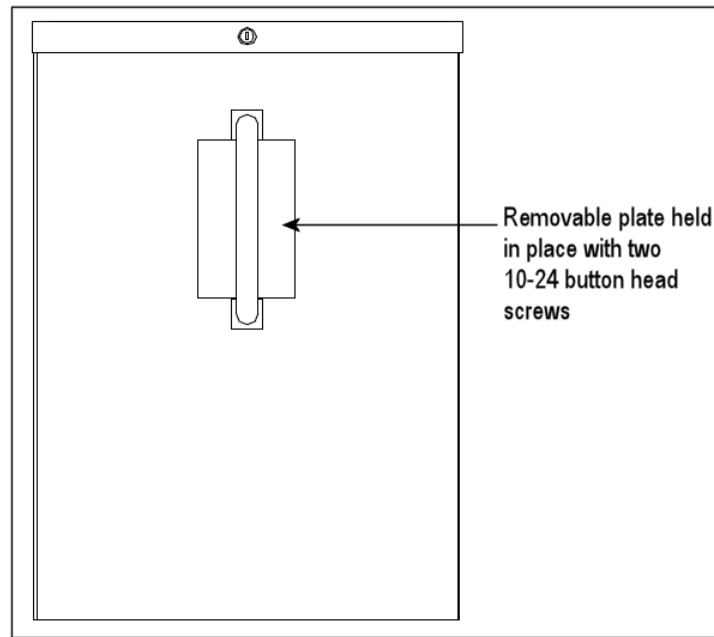

After the V-shaped plate is removed, the lid must be taken off of the cabinet. The lid is held in the front with a key lock and fits into two clips in the back. To remove the lid, first unlock the key, then pull the lid forward and lift up to unhook the clips in the back.

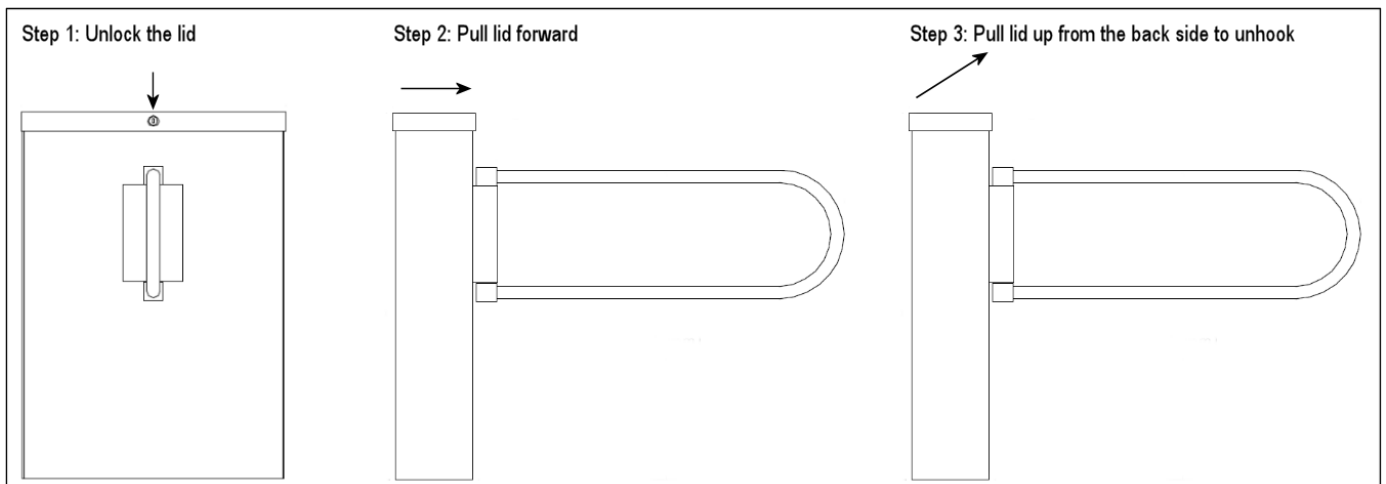

Pre-installation Preparation (cont.)

The next step before being able to access the floor plate is to remove the front panels of the cabinets. With the lid removed, two 10/32 screws are found in the top corners of each panel. Simply remove these screws and the front panel can be removed by tilting it forward and lifting it out of the floor plate

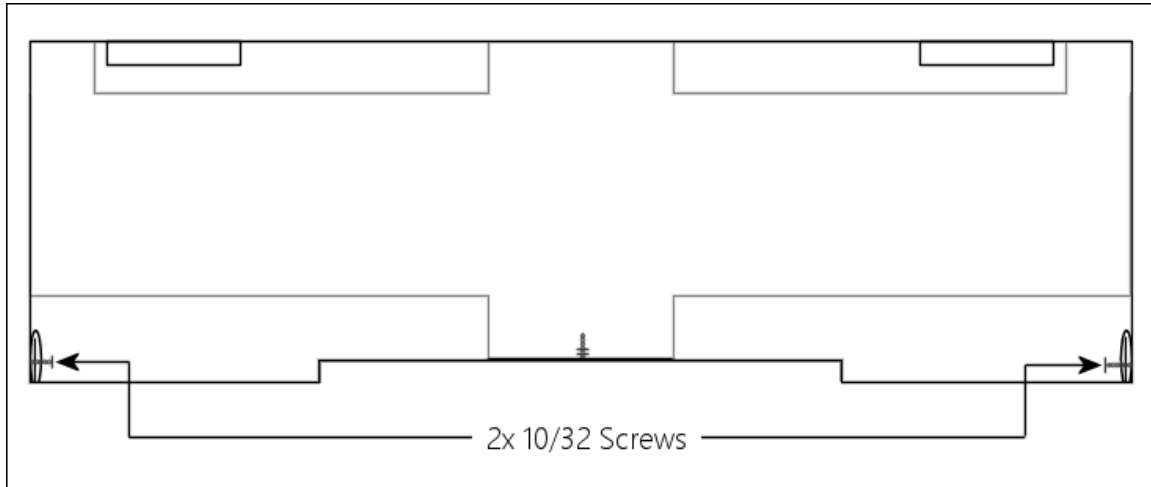

Although it should not be necessary, the sensors can be disconnected from their cables. Each sensor is equipped with an M8 euro style quick disconnect cable. These can be disconnected so that the panels can be completely removed from the area to provide more work space. Simply unscrew the thread on the cable where it connects to the sensor and remove.

Pre-installation Preparation (cont.)

Pre-installation Alignment:

Before anchoring the cabinets to the floor, we recommend laying out the lane and testing alignment.

Place the cabinets in their approximate end location and connect the 2 conductor cable inside of the primary cabinet to the end in the secondary cabinet. Plug in the primary cabinet to AC voltage to power up the lane.

Inside of the primary cabinet, there is a series of 7 total photo cell sensors. Each of these sensors is equipped with two LED's on the rear. One of them is green and should always be lit. The other should be solid orange while the beam is uncrossed and off while the beam is crossed.

If the orange LED is blinking in any case, you will need to adjust the sensor alignment, shift the cabinets so that they are straight to each other, or shim the cabinets so that they are level.

See the sensor alignment section of this manual for advice on how to ensure the transmitter's light reaches the receiver properly.

Wedge Type Concrete Anchor Instructions

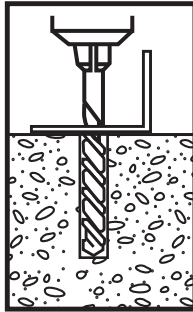

1

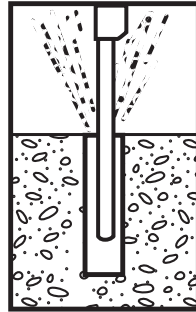

2



3

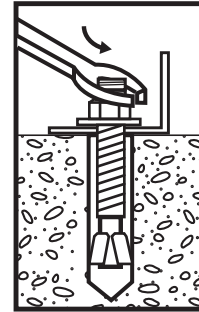

4

- 1** Select a carbide drill bit with a diameter equal to the anchor diameter. Drill hole at least 1/4" deeper than nominal anchor embedment.
- 2** Clean hole with pressurized air or vacuum to remove any excess dust/debris.
- 3** Using the washer and nut provided, assemble the anchor, leaving nut one half turn from the end of anchor to protect threads. Drive anchor through fixture to be fastened until washer is flush to the surface of fixture.
- 4** Expand anchor by tightening nut to the specified setting torque - see Table (approx 3 to 5 full revolutions).

Anchor Diameter & Drill Bit Size	Installation Torque Ft. lbs.*	Minimum Anchor Embedment	Minimum Hole Diameter in Fixture
3/8"	25	1-7/8"	1/2"
1/2"	45	2-1/2"	5/8"
5/8"	90	2-3/4"	3/4"

* Setting torque only applies at the time of installation.

Warning!

- ⚠** Use in concrete ONLY. Not recommended for use in lightweight masonry such as block or brick.
- ⚠** Always wear safety glasses and other necessary protective devices or apparel when installing or working with anchors.

Caution: Use of core drills is not recommended to drill holes for use with this anchor.

Do not use an impact wrench to set or tighten the anchor. Not recommended for use in concrete which has not had sufficient time to cure.

The use of carbide drill bits manufactured with ANSI B212.15 drill bit diameter requirements is recommended for installation of this anchor. Anchor spacing and edge distance (anchor installation locations) are the responsibility of the engineer of record.

Installing product in oversized holes is not recommended. Product will not set properly or achieve full designed load in oversized holes.

Installation Instructions

1. Floor should be level +/- 1/16". If not, each cabinet must be shimmed.



Note: Anchoring optical lanes to an uneven ground most likely will cause serious issues in unit operation.

2. Install conduit for 100-240 VAC to primary cabinet, conduit for access control integration (if applicable), and a 3/4" conduit in between the primary and secondary cabinet for cabling to the secondary cabinet.
3. With each cabinet in the exact position to be mounted, use a center punch to mark location of the four holes to be drilled in the floor.

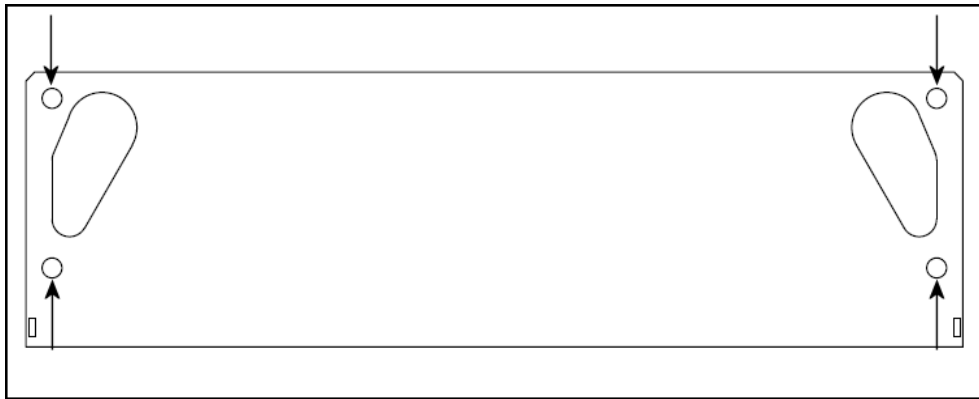

Note: Make sure each cabinet is square to each other, otherwise operation will be inconsistent

3. If necessary, move cabinets out of the way. Drill four 3/8" holes 4" deep per cabinet and remove all concrete dust from the holes.
4. Place cabinet in the correct location and install SS wedge type anchors supplied. Torque the nuts to a minimum of 50 foot pounds.
5. Plug the power supply in the main cabinet into 100-240 VAC (single phase) minimum 3 amp GFI circuit.
6. The sensors we use are a thru-beam type: they require a transmitter and receiver in order to operate. In order to accomplish this, you must connect 24VDC power to the secondary cabinet. This is accomplished with a provided 12 conductor (or 2 conductor for single lane add-on) cable. See the wiring diagram for more information.
7. Connect access control as required to direction inputs on the logic controller. See wiring diagram for more information.

Sensor Alignment

The EX300 series is equipped with visible target laser thru beam sensors. The transmitter sensors (located in the secondary cabinet) shine much like a flash light. The target from the transmitters can be visibly seen by simply placing a piece of white paper onto the target area.

Each photo cell is mounted onto a bracket which is screwed onto a panel.

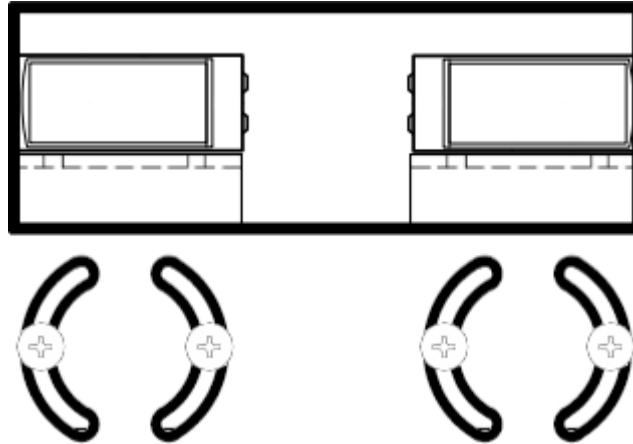

Loosening the screws holding the bracket to the panel will allow for some range of motion up and down.

The sensors can also be tilted on the brackets themselves to provide a left-to-right alignment adjustment. Simply loosen the screws holding the bracket to the sensor and tilt in the desired direction.

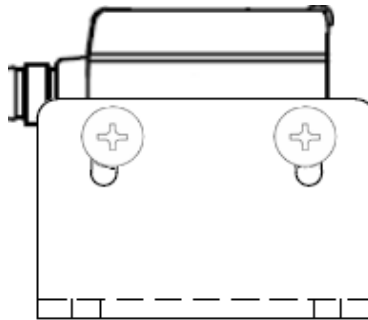

Note that the light from the transmitters will actually be larger than the surface area of the receivers. This makes alignment much easier. Try to center out the targets to the receiver as close as possible.

Sensor Designations

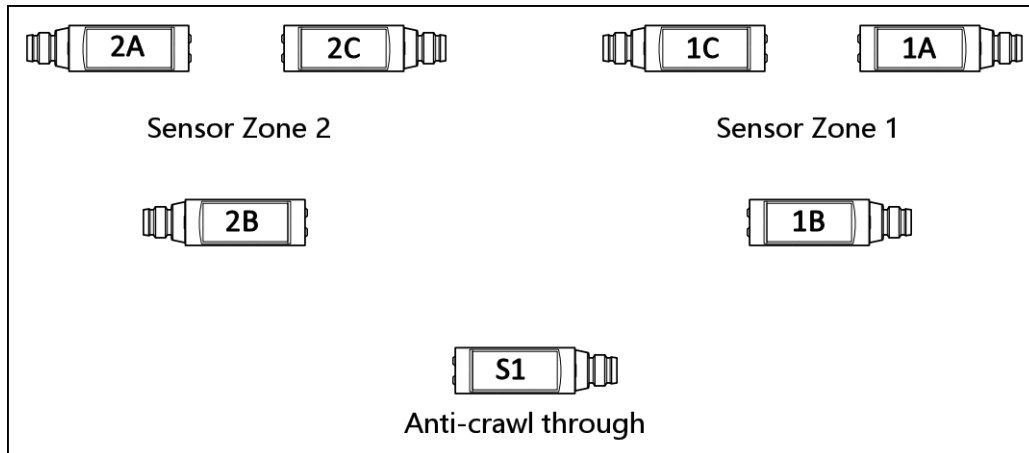

Above is a diagram which illustrates each sensor's position. There are 7 sensors on each cabinet total, separated into 3 "zones".

The zone designated as "Sensor Zone 1" is part of the intelligence behind whether or not authorized access has been granted. For example, if the zone 1 sensors have been tripped but direction 2 was the direction that authorization was granted, an alarm will trigger.

The zone called Sensor Zone 2 does the same thing as zone 1, but in the opposite direction.

The sensor zones have another function as well. On free flow mode, when the sensor zone for the appropriate direction is actuated, access is granted for that direction.

The third zone are sensors which prevent the arms from closing on obstruction and also serve as anti-crawl through sensors. These will detect unauthorized people who are attempting to crawl underneath the main zones.

EX300 Wiring Introduction

While very elaborate on the back end, the EX300 installation wiring is actually pretty simple. Most of the wiring is performed in the factory. In an effort to keep the diagrams more readable, several diagrams covering multiple aspects of the product are provided just in case.

However, during installation, the only wiring to be done is for access control, main voltage and interconnection from the primary side of a lane to the secondary. In terms of access control, a contact closure between 24VDC + and the desired input is needed from a relay (there could be as many as six relay inputs needed depending on how the product is intended to be used).

Interconnection is achieved with a 12 conductor cable (for ADA lanes) or a 2 conductor cable (for a single arm lane). In the factory, we terminate both ends of this cable during assembly, then snip off a short length on the secondary side for easy wire color matching. Some wires may not be used and can be used for other purposes such as adding devices to the unit.

Refer to the following diagrams provided for reference, but keep in mind that most of these terminations are already made for you.

The next page will act as a wiring legend to illustrate what each terminal on the PLC does. This diagram is followed by actual wiring schematics.

The first schematic labeled "Access Control and Indication" shows where all the access control terminations are supposed to land while the second diagram labeled "ADA Lane Secondary Cabinet Wiring Diagram" which shows the terminals to connect the interconnection cable to.

All other wiring diagrams provided are for troubleshooting and reference only.



EX300 Wiring Legend

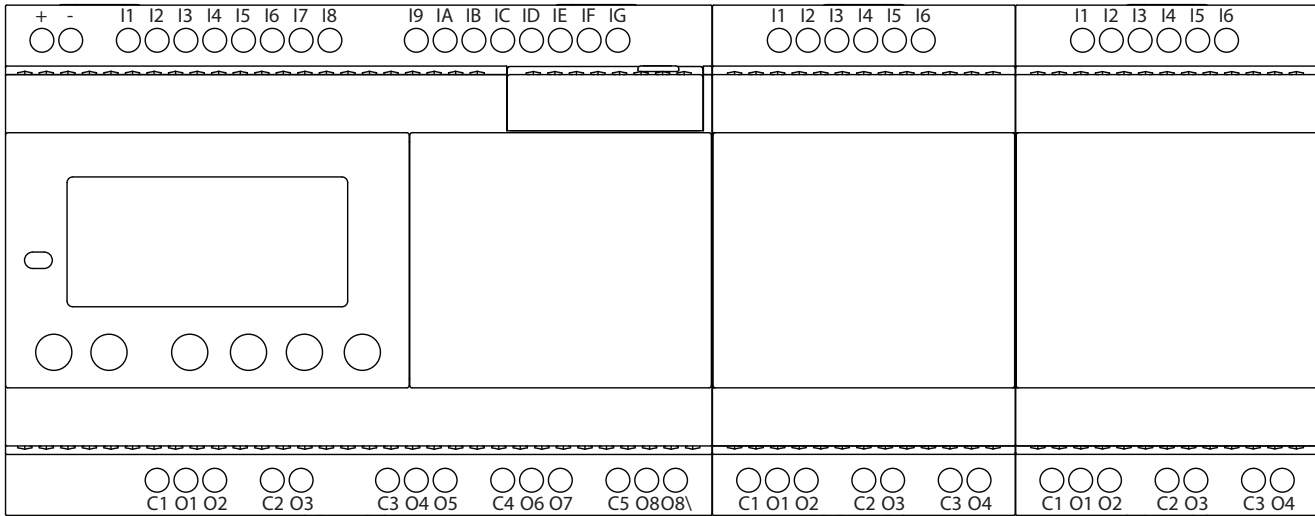

Main PLC Inputs

- + - Input 24VDC +
- Input 224VDC -
- I1 - Direction 1 Input
- I2 - Direction 2 Input
- I3 - Direction 1 Override
- I4 - Direction 2 Override
- I5 - Sensor 1A
- I6 - Sensor 1B
- I7 - Sensor 1C
- I8 - Sensor S1
- I9 - Sensor 2C
- IA - Sensor 2B
- IB - Sensor 2A
- IC - Arm 1 Dir 1 Prox
- ID - Arm 1 Home Prox
- IE - Arm 1 Dir 2 Prox
- IF - Arm 2 Dir 1 Prox
- IG - Arm 2 Home Prox

Main PLC Outputs

- C1 - Connect to 24VDC+
- O1 - Dir 1 Yellow LED
- O2 - Dir 1 Green LED
- C2 - Connect to 24VDC +
- O3 - Dir 1 Red LED
- C3 - Connect to 24VDC +
- O4 - Dir 2 Yellow LED
- O5 - Dir 2 Green LED
- C4 - Connect to 24VDC +
- O6 - Dir 2 Red LED
- O7 - Alarm (Solid State)
- C5 - Connect to 24VDC +
- O8 - Alarm (Pulsing)
- O8/ - Not Used

Expansion 1 Inputs

- I1 - Arm 2 Dir 2 Prox
- I2 - Direction 1 Approach
- I3 - Direction 2 Approach
- I4 - Direction 1 Mode Change
- I5 - Direction 2 Mode Change
- I6 - Not Used

Expansion 2 Inputs

- I1 - Not Used
- I2 - Not Used
- I3 - Not Used
- I4 - Not Used
- I5 - Not Used
- I6 - Not Used

Expansion 1 Outputs

- C1 - Connect to 24VDC+
- O1 - Arm 1 Dir 1 Solenoid
- O2 - Arm 1 Dir 2 Solenoid
- C2 - Connect to 24VDC +
- O3 - Arm 2 Dir 1 Solenoid
- C3 - Arm 2 Dir 2 Solenoid
- O4 - Dir 2 Yellow LED

Expansion 2 Outputs

- C1 - Connect to 24VDC+
- O1 - Arm 1 Motor CW
- O2 - Arm 1 Motor CCW
- C2 - Connect to 24VDC +
- O3 - Arm 2 Motor CW
- C3 - Arm 2 Motor CCW
- O4 - Dir 2 Yellow LED

All inputs are PNP type transistor inputs - apply local 24VDC + to terminal for PLC to register.

Installations may use as few as one contact closure and as many as six depending on the complexity of the application.

To activate multiple lanes at the same time, each lane must source it's input from the same power supply it comes from. Add ice cube relays to trigger multiple lanes together to ensure the power for the input is coming from the same power supply the PLC is.

All outputs are relay outputs. Many of these share commons. These commons are all tied to 24VDC+.

You may piggyback onto one of the common terminals to get 24VDC to operate other devices.

Other notes: Direction 1 is with the primary cabinet on your left, Direction 2 is the primary cabinet on the right.

Single arm lanes will not use as many terminals. Anything relayed to Arm 2 will be missing in this instance.

EX300 Access Control & Indication Wiring Diagram

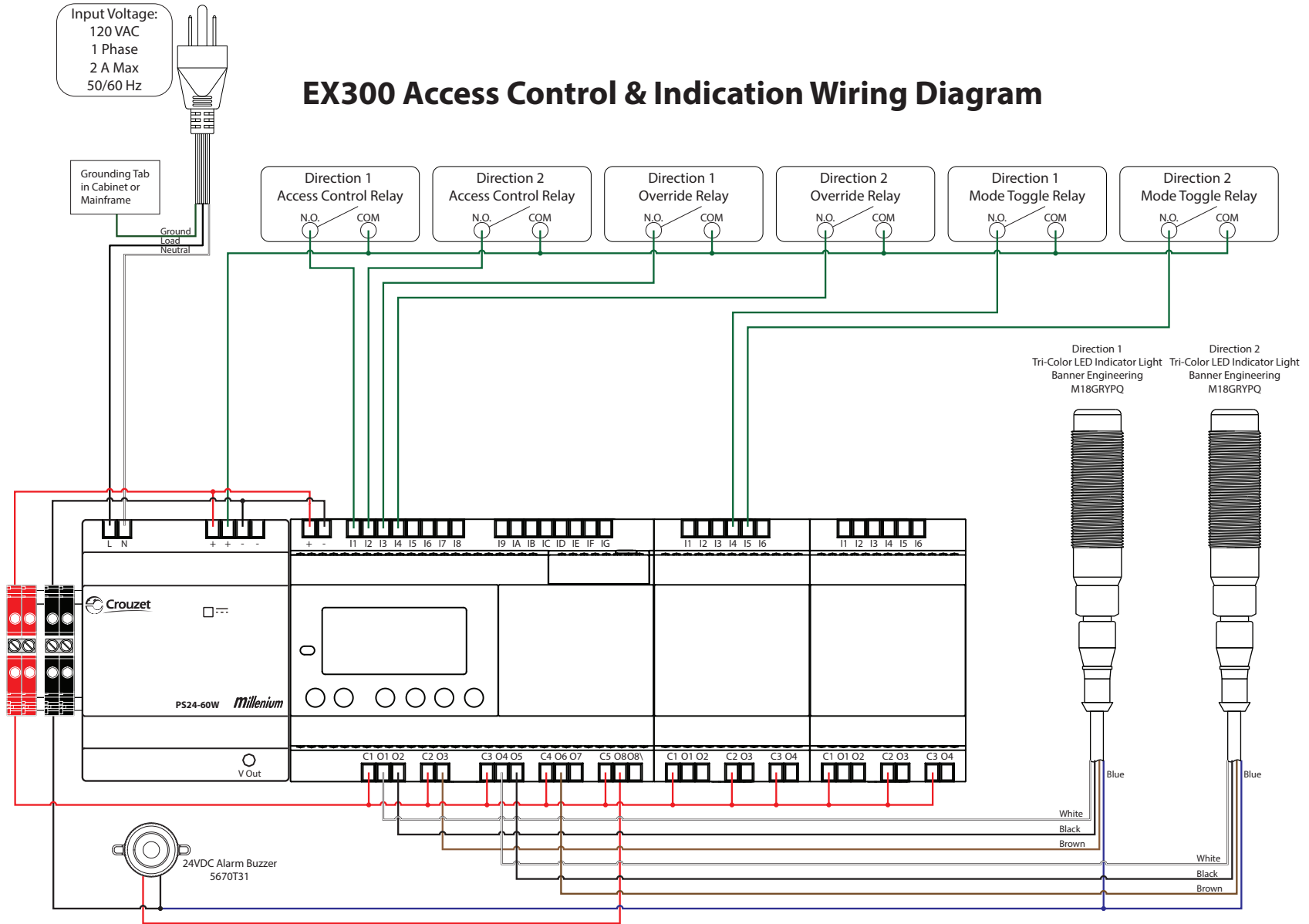

EX300 ADA Lane Secondary Cabinet Wiring Diagram

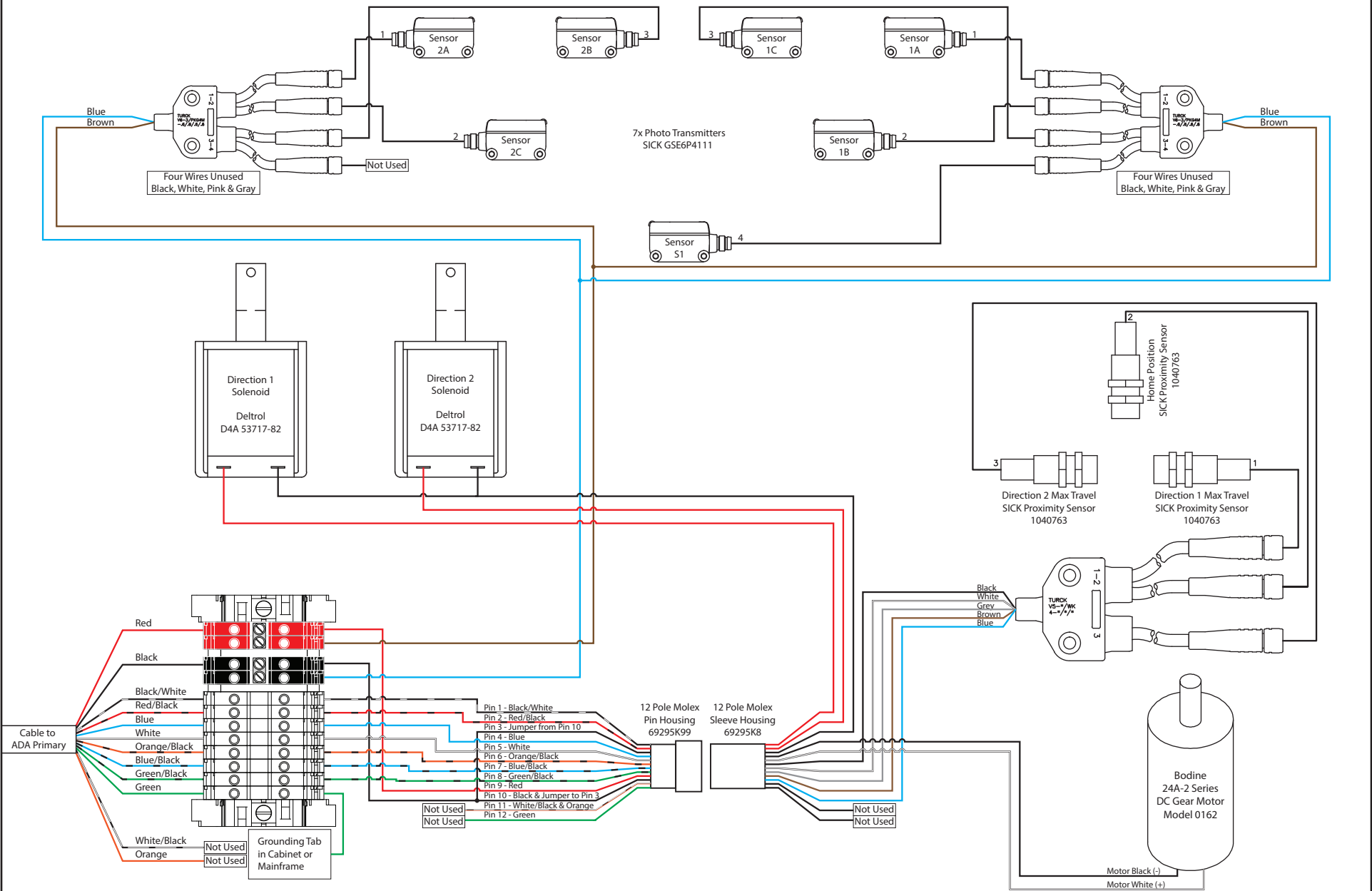

12/4/2018

TURNSTILES.us. EX300 Primary Cabinet Motion Control Wiring Diagram

SECURING THE U.S. and the GLOBE

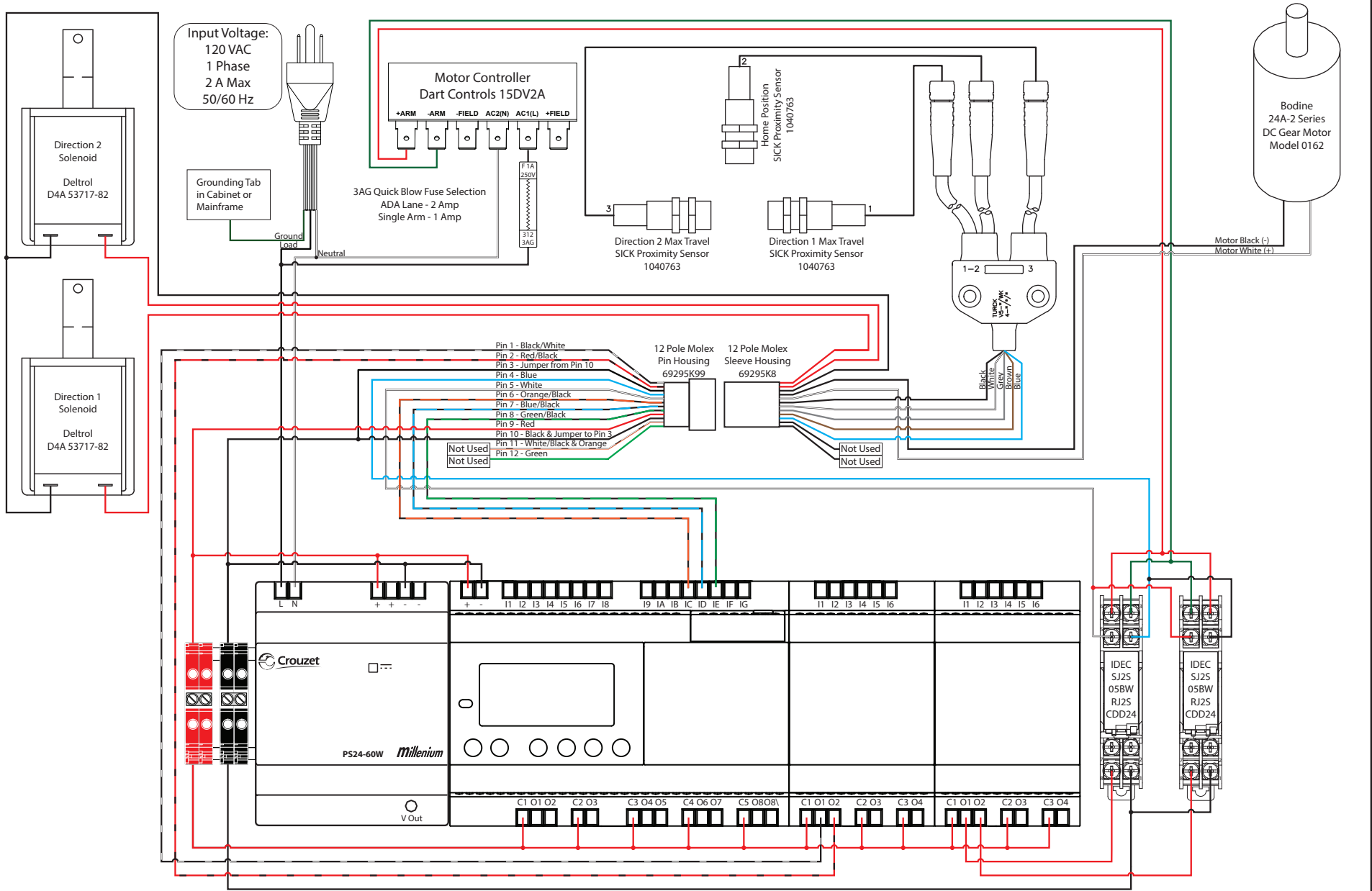

12/4/2018

TURNSTILES.us. EX300 Primary Cabinet Optical Sensor Wiring Diagram

SECURING THE U.S. and the GLOBE

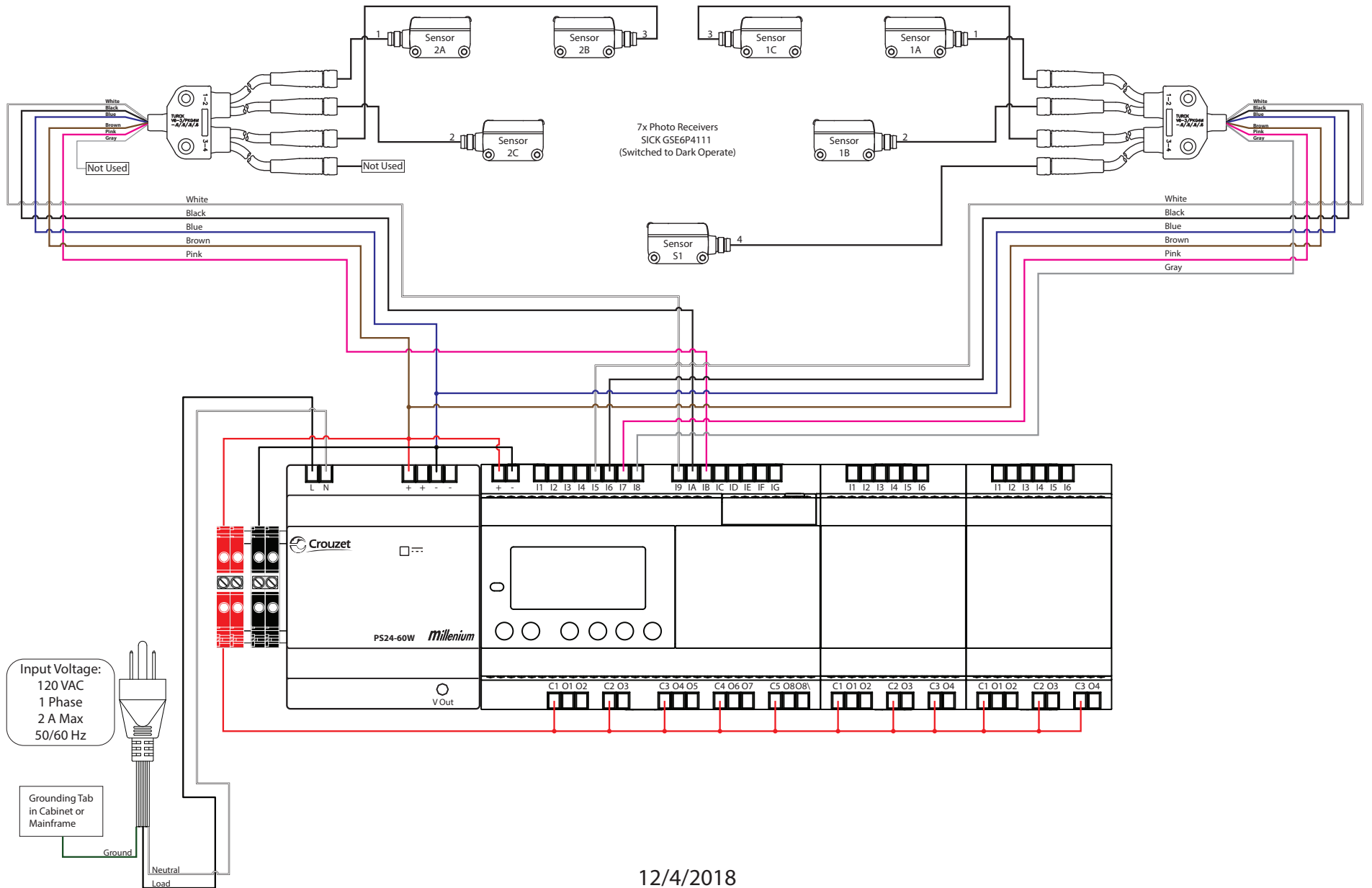

12/4/2018

EX300 ADA Lane Primary to Secondary Cabinet Interconnection Wiring Diagram

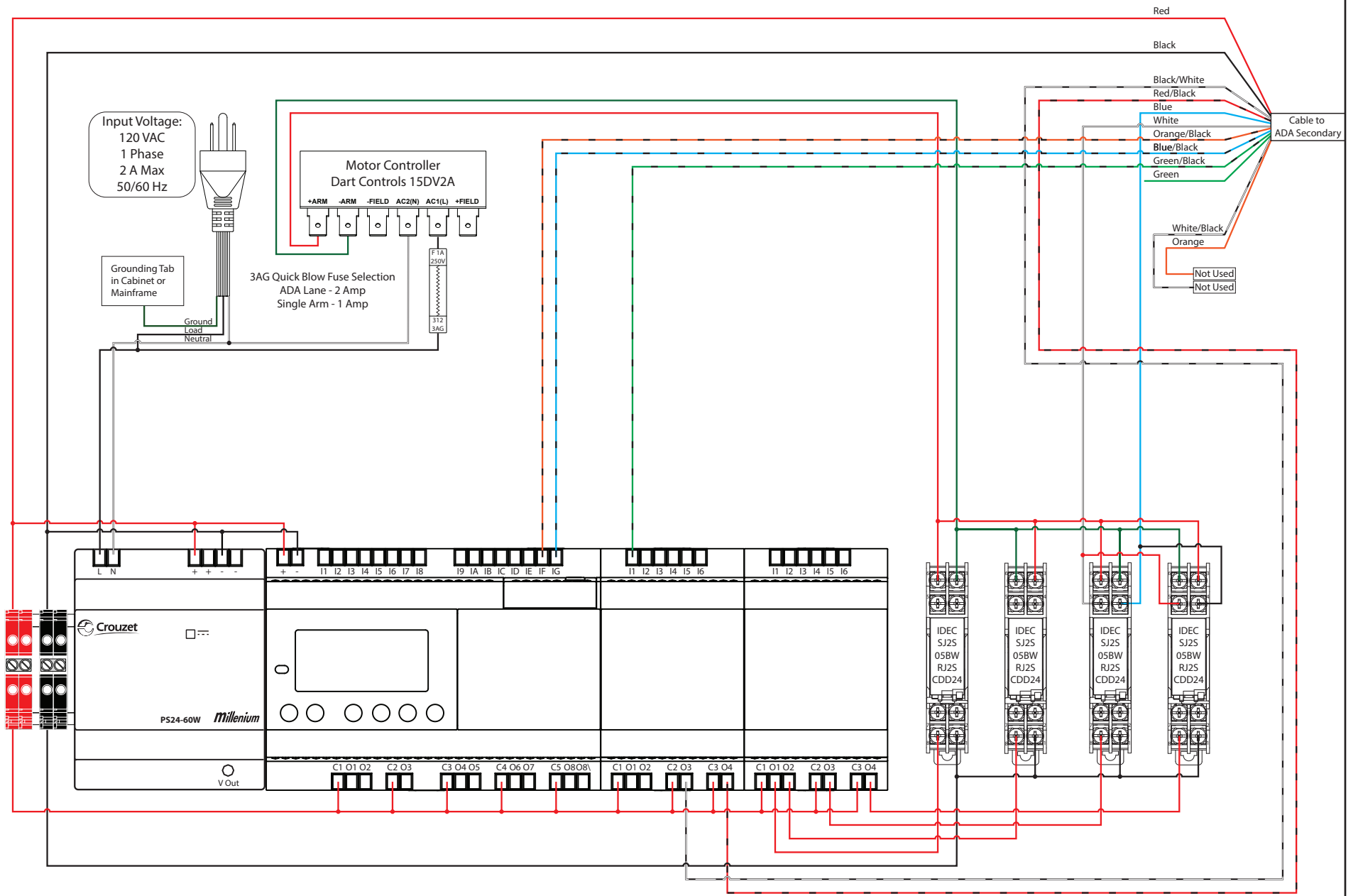

12/4/2018

EX300 Settings & Statistics Menu

The EX300 has a large number of settings that can be adjusted to accomodate many scenarios as well as a lengthy set of statistical data it logs for troubleshooting and maintainence purposes. It is important to note that all settings come from the factory preconfigured based on job specific requirements as well as typical environment usage. Most settings will never need to be adjusted but can be just in case some aspect of the installation needs tweaked.

The Home Screen

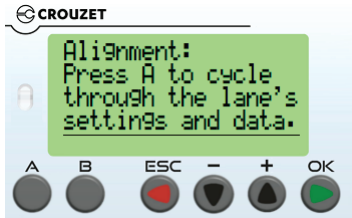

This screen is the default for the EX300. It will automatically return to this screen after 15 minutes or by pressing the B button. The most important aspect of this screen is that it provides information on sensor alignment. Under normal circumstances, nothing should be shown after alignment. Possible readouts include 5, 6, 7, 8, 9, A and B, which correspond to each input for the photo sensors. If one or more of these is showing on the Alignment line, the corresponding sensor is out of alignment, blocked or not functioning properly.

Testing Mode

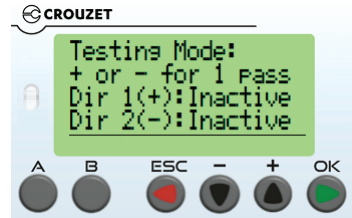

This screen allows for the lane to be activated in either direction based on how the lane is set up. The lane will not activate from this window if a direction is set to free passage. Press + to activate the lane in Direction 1 and - to activate the lane in Direction 2. Multiswipes are also allowed from this window based on the Swipe Queue setting.

Main Timer Values

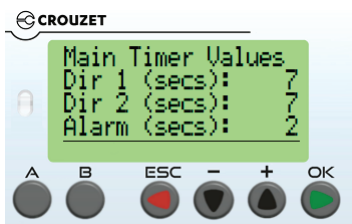

From this screen, each directional timer can be adjusted. These timers are how long someone has to pass through the lane before it cancels and returns to the home position. Passage through the lane also cancels the timer. The default is 7 seconds for either direction. The duration of the audible alarm (after source of alarm has been cleared) to sound is also adjusted here. To adjust, press up or down to select which value to change, press OK to select, press up or down to adjust, then press OK to save. The factory suggests 7 seconds on either directional timer and 2 seconds for the alarm timer.

Direction 1 Primary Mode



The value on this screen defines the standard operation of direction 1. It can be set to Controlled Passage (w/ yellow indicator lights), Free Passage (w/ green indicator lights) or No Passage (w/ red indicator lights). Controlled or Free are the most common settings, but if there are multiple lanes, using No Passage may help to spread traffic through multiple lanes. This is configured based on our understanding of the job requirements in the factory, but can be cycled by pressing the + button.

Direction 2 Primary Mode

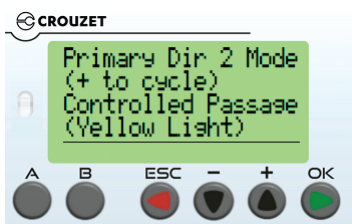

The value on this screen defines the standard operation of direction 2. It works the same as the direction 1 setting. Press + to cycle between Controlled Passage, Free Passage or No Passage.

Direction 1 Secondary Mode

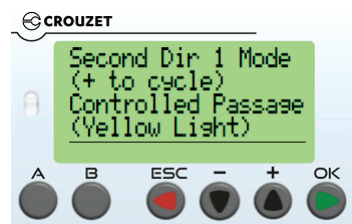

The value on this screen defines the secondary operation of direction 1. Upon applying voltage to the Direction 1 Mode Change input, the lane will switch to this secondary mode of operation. This is handy for facilities that frequently need to change what their lanes are doing. Press + to cycle between Controlled Passage, Free Passage or No Passage.

EX300 Settings & Statistics, continued

Direction 2 Secondary Mode

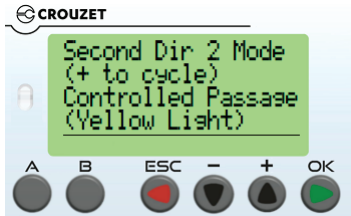

The value on this screen defines the secondary operation of direction 2. Upon applying voltage to the Direction 2 Mode Change input, the lane will switch to this secondary mode of operation. This is handy for facilities that frequently need to change what their lanes are doing. Press + to cycle between Controlled Passage, Free Passage or No Passage.

Crawl-Thru Settings

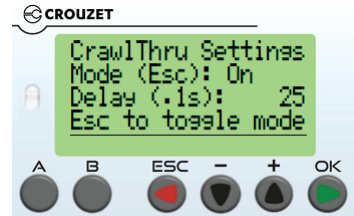

The value on this screen defines how the anti-crawl thru functionality works. If enabled, when sensor S1 is blocked for the adjustable duration shown on this window, the alarm scenario for anti-crawl thru detection is activated. Adjust the timer value by pressing OK then increasing or decreasing the setting and pressing OK again to save. Toggle this setting to disable it or enable it by pressing ESC.

Photo Sensor Filter Delay

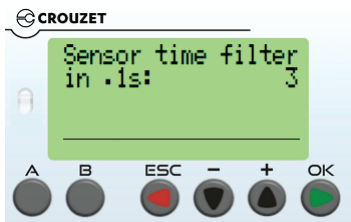

The value on this screen defines how long sensors must be blocked before registering. Lessening the timer will make the units more sensitive. Typically, a range of 1 to 3 is a good setting here. This filters out quick accidental beam crosses without allowing too much through.

Swipe Queue Settings

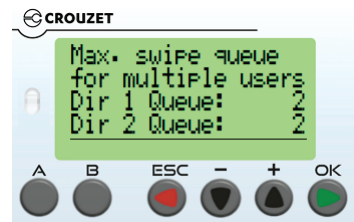

This screen allows the number of people who can swipe their card ahead of time. Most installations would benefit from a value of 2, but more secure areas may wish to reduce this to 1. Very fast paced installations may wish a value of 3, but as a person passes through another access control request is allowed.

Linger Alarm Setting



The value on this screen defines how much time someone has to get out of the path of the beams once the lane has determined someone has passed through it. Increasing this timer can be beneficial for slow moving people but the caveat is that it decreases security to do so.

Approach Alarm Delay

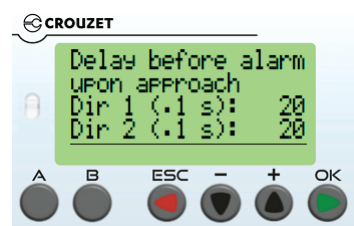

The value is only applicable to controlled passage directions. If the lane is in the home position, the unit will wait for the duration listed before setting the lane into alarm. The reason for this is many times in their haste, people will walk into the lane before swiping their badge. If the arm is open or closing at the time of entry, the alarm will sound regardless of this setting.

EX300 Settings & Statistics, continued

Solenoid Settings

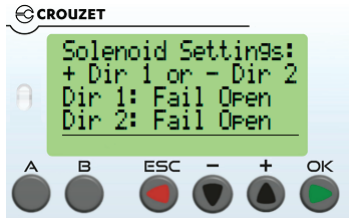

This screen is preconfigured in the factory based on requested operation. Solenoids may be fail open or fail lock in one or both directions. Changing this setting will cause adverse operation unless the appropriate mechanical changes are made to go along with them.

Override Swing & Lane Type

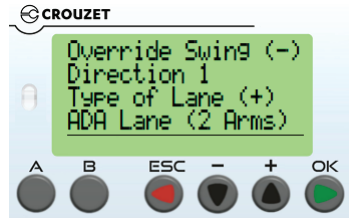

The first setting defines which way the arm swings in the event both directional overrides are activated at the same time. It is toggled between direction 1 and direction 2 by pressing the - Button. The second part is configured in the factory based on the lane type purchased and should not be changed.

Motor Delay Value

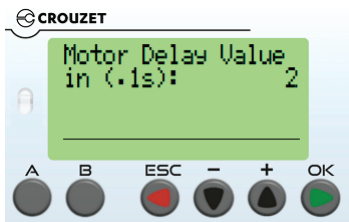

This setting adds a slight pause to the motor before running in the opposite direction to protect the circuitry. There is not really any need to adjust this beyond its preconfigured setting of .2 seconds.

Bind Recovery Settings

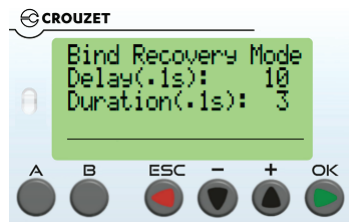

In the event the arm attempts to move forward for the duration of the first value, but is unable to due to it being out of position and binding against the locking bar, it will automatically reverse it's swing for the second value. The only reason to adjust this is if the motor controller has been set to a reduced speed.

Free Exit Approach Sensor Cancel Delay



Units purchased as having a free passage direction come with an additional outfacing sensor to activate the lane a bit earlier. While not necessary to operation, it adds to the user friendliness of the lane. This setting adjusts how long it takes for the arm to return if it opened but nobody walked through.

Arm Closing Delay

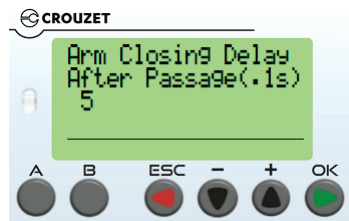

After a lane is passed through, the arm will wait for the above value to expire before it begins to close. This is a good setting to adjust if people are saying the arm is moving too quickly for them.

EX300 Settings & Statistics, continued

Direction 1 Passage Counter

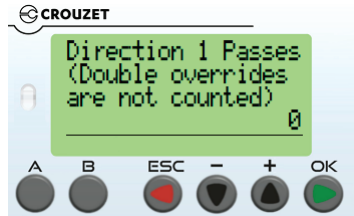

This screen has a readout showing how many people have passed through the lane in direction 1 (outside of a double override scenario). It is good information for maintenance.

Direction 2 Passage Counter

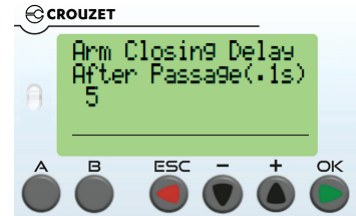

This screen has a readout showing how many people have passed through the lane in direction 2 (outside of a double override scenario). It is good information for maintenance.

Approach / No Swipe Alarm



This screen lists how many times the alarm went off because the arm was approached without swiping (whether while closing or while in the closed position).

Piggyback Alarm Counter



This screen lists how many times someone attempted to piggyback through the lane on someone else's access control request without swiping themselves.

Wrong Way Alarms



This screen lists how many times the alarm went off because someone from one side requested passage but someone on the other side went through without swiping their own badge.

Anti-crawl & Linger Alarms

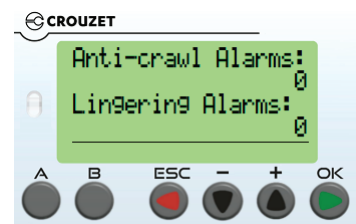

This screen lists how many times the anti-crawl through alarm or the linger in beam alarm occurred (as defined in previous settings).

EX300 Settings & Statistics, continued

Arm 1 Binding Data

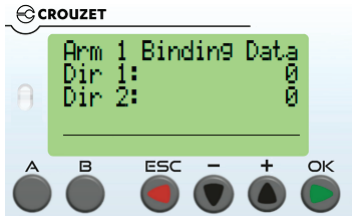

This screen lists how many times the bind recovery scenario happened for either direction on Arm 1.

Arm 2 Binding Data

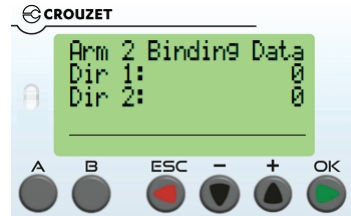

This screen lists how many times the bind recovery scenario happened for either direction on Arm 2. Single arm lanes will automatically skip this window.

Lane Specific Values

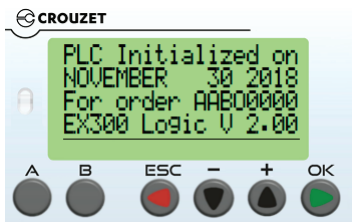

This lane shows when the PLC was activated for the project, the order number the lane was for and the logic version. This is very helpful information to technical support so the specifics to the project can be reviewed.

Factory Setup Screen

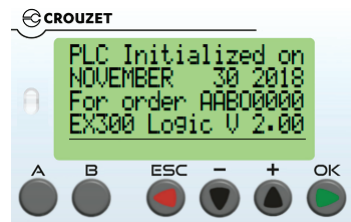

This window should never appear unless something happens to completely restart the logic. If this occurs somehow, enter the order number if known by pressing the A, B, - & + buttons to add one to each digit.

Backend Screens

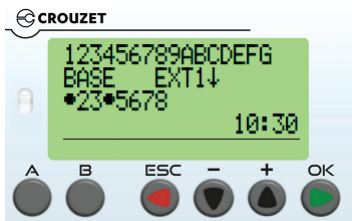

A variety of different readouts and menus for the backend of the logic controller are available. It is best to avoid tinkering here to avoid accidentally resetting the logic and losing all of the project settings. Avoid holding escape and if this manages to enter any further menus, try not to "stop" and then "reset all values and start" the logic.

Warranty Information

Seller warrants the goods against defective workmanship and materials provided that Buyer notify Seller within one (1) year after receipt by Buyer of the goods of any claim under this Warranty. The liability of Seller shall be limited to replacing or repairing defective goods returned by Buyer and delivered to the factory of the Seller, transportation charges prepaid.

Replaced or repaired goods will be redelivered freight prepaid to the address of Buyer shown hereon. Except for the Warranty contained herein, there shall be no other warranties, such as warranties of fitness and merchantability or otherwise express or implied, written or verbal, and Seller shall not be liable for consequential damages in any event.