

## P-60 Full Height Turnstile

### Service & Installation Manual



**Note: Successful turnstile installation depends on reading this manual.**

Important Note: Please keep this service manual after installation. If an installation is done by a construction company or outside installer, please pass this book along to the end user. This book is required for maintenance, troubleshooting, and repairs.

Table of Contents

Important Electrical Information	3
P60 Spec Sheet	4
P60 Foot Print	6
List of Materials	7
Installation Instructions	8
6500 Series Control Head Mechanical Information	13
Control Head Parts Breakdown	14
Control Head Parts List	15
6500 Series Control Head Configurations	16
Locking Bar Information	17
Shock Adjustment / Replacement	19
Control Head Electrical Information	20
Wiring Diagram	21
Wiring Legend	22
6500 Series Control Head w/ XD10 Controller Standard Turnstile Settings	23
6500 Series Control Head w/ XD10 Controller Standard Turnstile Testing	24
6500 Series Control Head Limit Switch Information	25
Maintenance & Cleaning	26
Troubleshooting	27
Proper Turnstile Usage	30
Warranty Information	31
Appendix: Spec. Sheets, Options, Etc.	32



## **Important Electrical Information**

**Installation of the control head mechanism into the turnstile requires a grounding-type outlet receptacle installed inside of the frame or cabinet through the provided conduit access points.**

**To reduce the risk of electric shock, this equipment has a grounding type plug that has a third (grounding) pin. This plug will only fit into a grounding type outlet. If the plug does not fit into the outlet, contact a qualified electrician to install the proper outlet. Do not change this plug in any way.**

**Additionally, the MS2-H50 power supply from this appliance must be grounded to the frame of the turnstile. Utilize the green colored grounding screw threaded into the grounding tab located near the power supply along with the provided grounding wire from the power supply to ensure the equipment is proper grounded.**

## Full-Height Turnstiles • Interior & Exterior Application

The Tiffany P60 unit is a three-vane turnstile with a weather resistant finish and automatic indent Feather-Touch action – that includes shock suppressor and non-entrapment features. It uses 6005-T6 anodized aluminum extrusions and GE's transparent Lexan™ polycarbonate cage panels. The P60 offers a canopy in addition to Lexan arms for a more modern open look.



### **We're the #1 Choice of Top Architects, Security Pros and Government Engineers**

*For two decades, TURNSTILES.us has been the globally trusted name in pedestrian control equipment. Made in Ohio and shipped worldwide, we are the first choice of leading architects, facility managers, security consultants and government engineers. Whether your project requires high-security, full-height turnstiles, waist-high units, or matching ADA accessible gates, TURNSTILES.us is the secure choice. And, we're experienced in access control systems, from card readers to biometric scanning, to give you the power to control access.*

Made in Ohio...  
In-Service World-Wide

### **P60 Series**

The P60 is equipped with GE Lexan™ polycarbonate arms for a modern, un-caged appearance.

**Arms:** .75" x 21" x 28"

**Exterior Height:** 94" to 102" available

**Interior Height:** 84"

**Width:** 72"

**Pedestrian Clearance:** 30"



Available as a Metal-Detect Door where higher security needs exist. Metal detection and bullet-resistant panels are available in varying performance specs based on your application.

## Full-Height Turnstile • Interior & Exterior Application

### Applications:

Featuring a canopy and Lexan™ arms for a more modern, open look, the P60 turnstile is a three vane turnstile with weather resistant finish and automatic indent Feather-Touch™ action (that includes shock suppressor and non-entrapment features).

### Product Features:

#### Model P60:

Uses polycarbonate arms for a modern, un-caged appearance, 94" to 102" available exterior height, 84" interior height, 72" deep; 75" width, .75" x 21" x 28" arms.

#### Installation:

Detail drawings, installation and maintenance instructions shall be furnished by the manufacturer.

#### Materials:

P60 uses 6005-T6 anodized aluminum extrusions and GE's transparent Lexan™ polycarbonate cage panels, fluted design support with 4 mounting columns for retaining barrier arms, spacers and panels by means of concealed roll-spring pins. Center column has three equally spaced recesses for retaining arm assemblies. The P60 is equipped with GE Lexan™ polycarbonate arms.

#### Control Mechanism:

Advanced modular design is equipped with auto-indexing, adjustable shock suppression, permanently lubricated bearings, hardened alloy cams and locking bars.

#### Finish:

Standard anodized finishes are clear, dark bronze and black.

#### Pedestrian Flow Movements:

Standards: free-flow, no flow, and controlled flow each separate direction.

#### Control Options-Lock:

Includes 24 VDC power supply, solenoid, Lock assembly, logic controller with card reader interface.

#### Pedestrian Flow Movements:

Card readers, fingerprint scanners, push buttons, token acceptors, consult factory for other options.

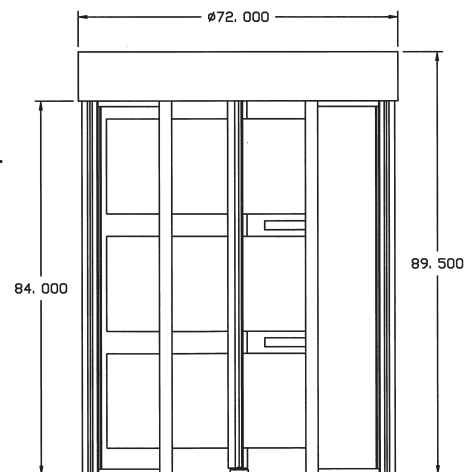
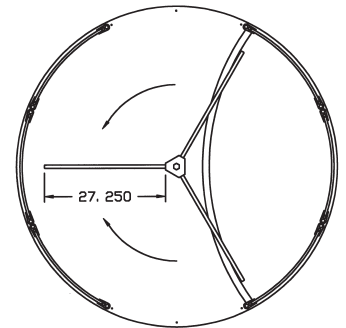

#### Electrical Specifications:

Command module input 110-240 VAC (2 amp-1 amp) 50-60 Hz; control voltage 24 VDC. All electrical components are UL recognized and CSA certified.

#### Warranty:

Units are warranted against defects in materials and workmanship for a period of one year from date of delivery. See warranty information for specific details.

P60 Footprint

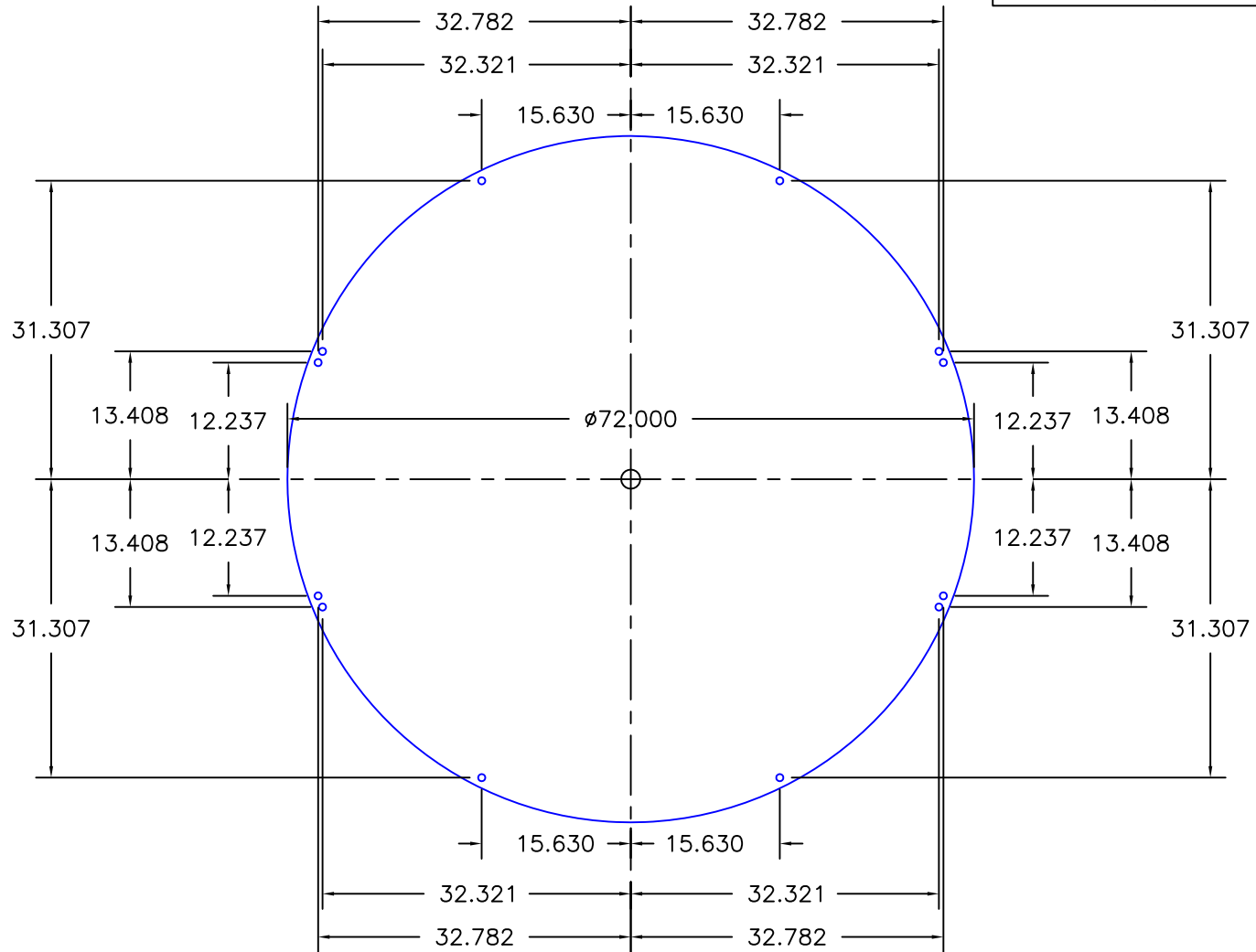

	SCALE: HALF	APPROVED BY:	DRAWN BY: LC III
	DATE: 8/27/04		REVISED:
	MATERIAL: N/A		
	FINISH: N/A		
	TOL. UNLESS OTHERWISE SPEC.	DRAWING NAME:	
.X ± .1      .XXX ± .015	P60 FOOT PRINT		
.XX ± .03      ANGLES .5°			

**MATERIALS**

<b>QTY</b>	<b>DESCRIPTION</b>
1	ROTOR ASSEMBLY
1	BOTTOM ROTOR FLANGE
1	BOTTOM ROTOR BEARING
3	CAGE PANELS WITH ¼" LEXAN BETWEEN EXTRUSIONS
2	CAGE PANEL WITH EXISTING HOLES INSIDE ONE EXTRUSION THAT WILL BE USED FOR THE CARD READER MOUNTING PLATES
1	CAGE PANEL WITH ¾" PINS IN THE TOP & BOTTOM OF ONE EXTURSION, THIS CAGE PANEL WILL BE USED AS THE SERVICE PANEL
9	¾" X 90" SUPPORT RODS (THREADED BOTH ENDS) FOR CAGE PANELS
2	¾" X 90" SUPPORT ROD HOLLOW (TREADED BOTH ENDS) FOR CAGE PANEL WITH EXISTING WIRES FOR EXIT SWITCH
3	KP DOUBLE "TWO WAY EXPANSION" ANCHORS FOR BOTTOM ROTOR FLANGE
1	LIQUIDROC 300 EPOXY POUCH (AS NEEDED)
1	CANOPY PLATE STEEL FRAME WITH ALUMINMUM FACE
4	CANOPY WRAP ⅛" x 53 ½" x (user specified height) ALUMINUM
11	¾" NUTS FOR THE TOP OF THE CAGE PANEL SUPPORT RODS
4	⅜" CONTROL HEAD NUTS
4	⅜" WASHERS FOR THE CONTROL HEAD
4	⅜" LOCK WASHERS FOR THE CONTROL HEAD
1	CONTROL HEAD WITH 2 LIMIT SWITCHES, POWER SUPPLY, AND CONTROL BOARD
24	10 – 32 X ½" FLAT HEAD MACHINE SCREWS FOR CANOPY WRAP

## INSTALLATION INSTRUCTIONS FOR P60 CARD ACCESS TURNSTILE

### 1. PREPARATION

- 1.1 Put canopy plate on the ground where the turnstile will be installed.
- 1.2 Trace holes in canopy for cage anchors and rotor center as shown below

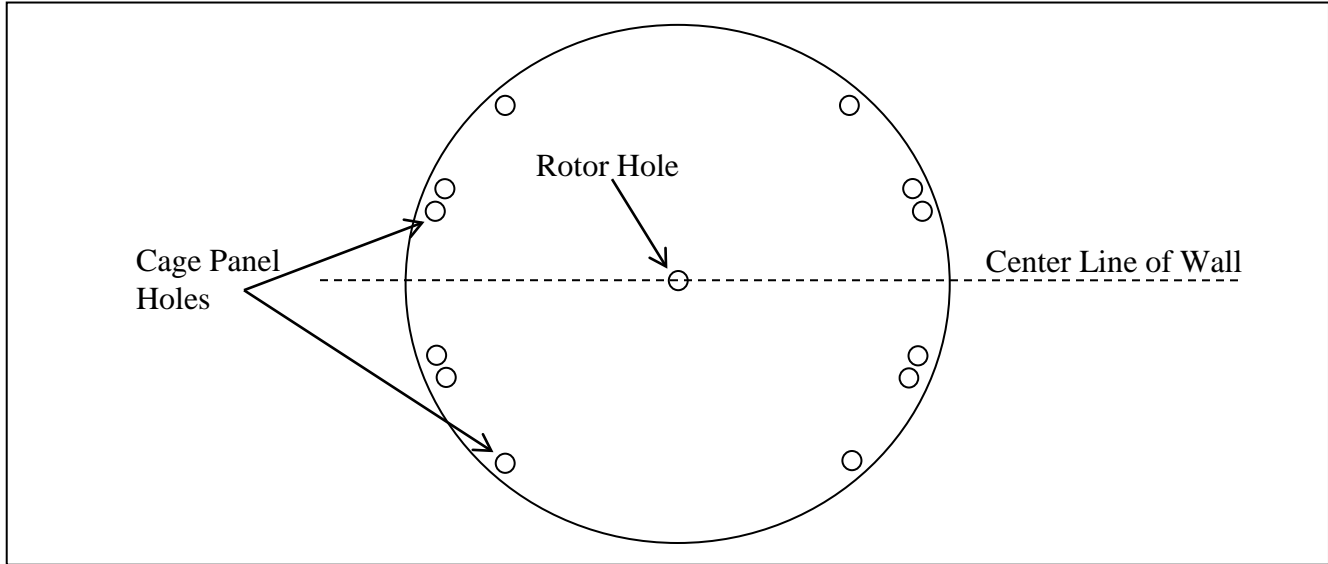

- 1.3 Remove canopy and place rotor bottom flange on the floor centered over the traced rotor circle
- 1.4 Trace the three (3) anchor holes for the bottom bearing
- 1.5 Drill three (3) 3/8" holes to a depth of 2 1/4" for the rotor anchors
- 1.6 Drill twelve (12) 7/8" holes to a depth of 4" for the cage panel anchors
- 1.7 Clean holes and remove all debris (use nylon brush if necessary)



**2. CAGE PANELS INSTALLATION**

2.1 Place two (2) 3/4" X 90" rods (threaded on both ends) through the hole in the cage extrusions. One (1) panel for each turnstile will be dedicated as a service panel that will be able to swing out. Therefore the service panel will only have one rod because the other side already has 3/4" pins in the top and bottom. Each cage panel has two (2) extrusions, one on each end as shown below:

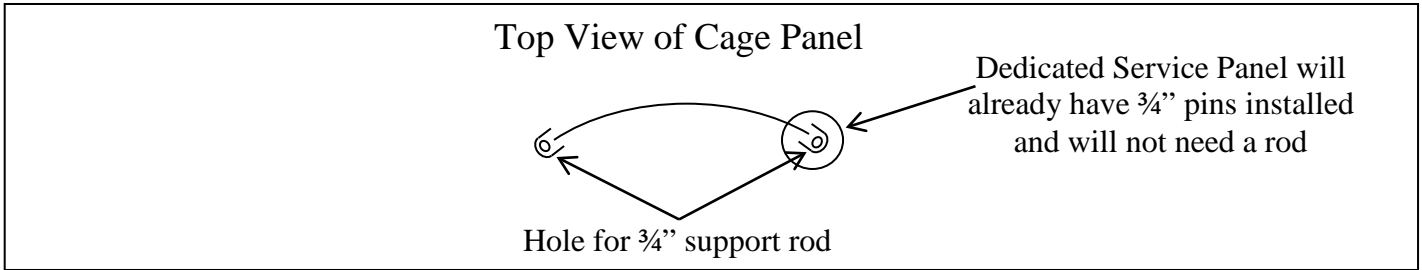

**CAUTION: DO NOT FILL THE 7/8" ANCHOR HOLE THAT IS FOR THE SERVICE PANEL WITH EPOXY ANCHORING GEL. ONE (1) PANEL WILL BE ABLE TO SWING OUT TO ALLOW THE ROTOR TO BE PLACED LATER**

2.2 Fill 7/8" anchor holes with Epoxy 1/3 full except for service panel holes shown below (follow directions provided with epoxy anchoring gel)

2.3 There are six (6) cage panels for each turnstile, three (3) on each side as shown below.

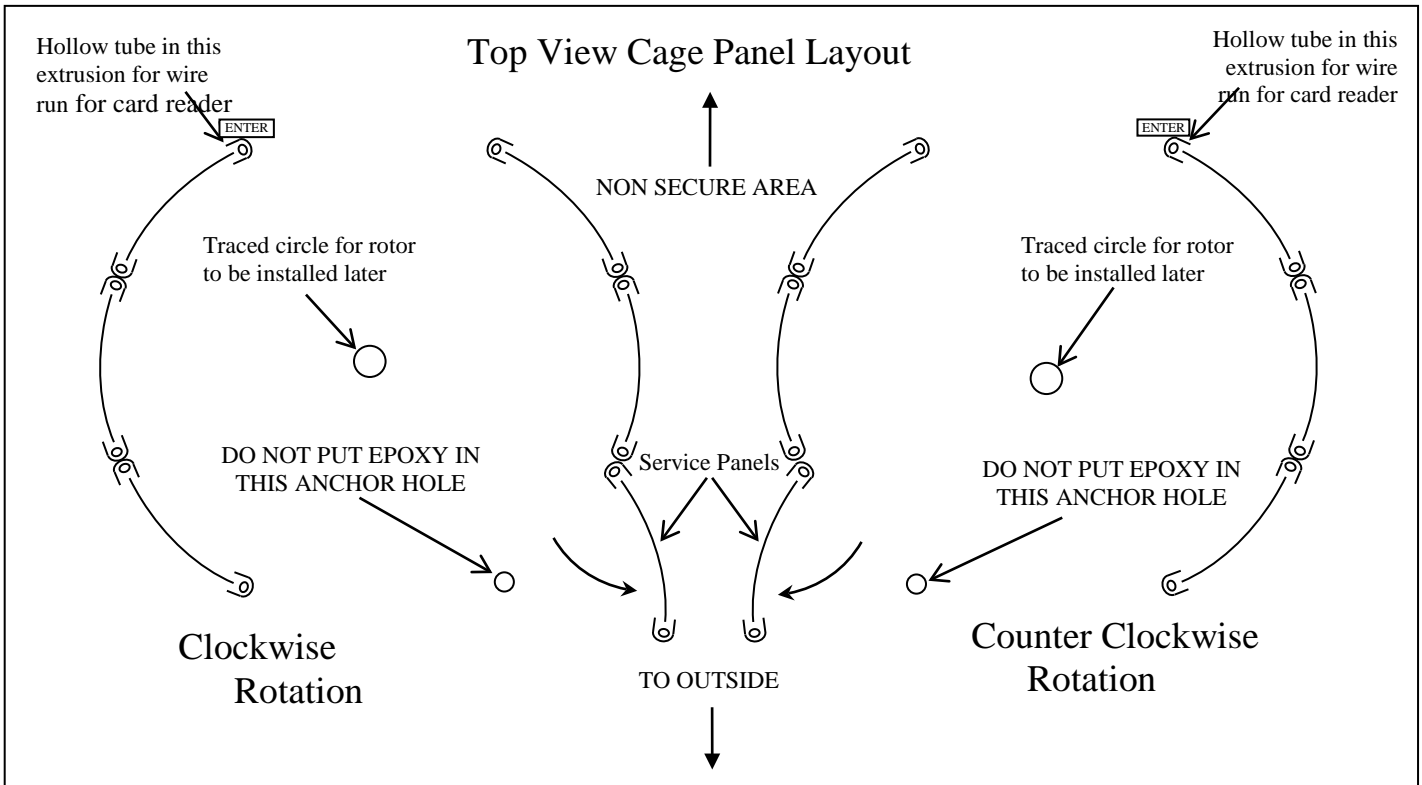

2.4 Move cage panels in place and allow the 3/4" cage panel support rods to drop into the anchor hole  
 2.5 Be sure to wipe up any epoxy that over flows as a result of the rod being placed in the hole

### 3. CANOPY INSTALLATION

#### 3.1 Raise canopy plate above the cage panels

**CAUTION:** BE SURE THAT THE CANOPY IS PLACED IN THE CORRECT ROTATION SO THAT THE HOLE FOR THE WRONG WAY SENSOR (**USED ONLY FOR REVOLVING DOOR P60 TURNSTILE NOT NEEDED**) IS ABOVE THE CORRECT AREA. SEE BELOW FOR CANOPY ORIENTATION.

#### 3.2 Line up correct holes with rods as shown below: **LIGHTS ARE OPTIONAL,**

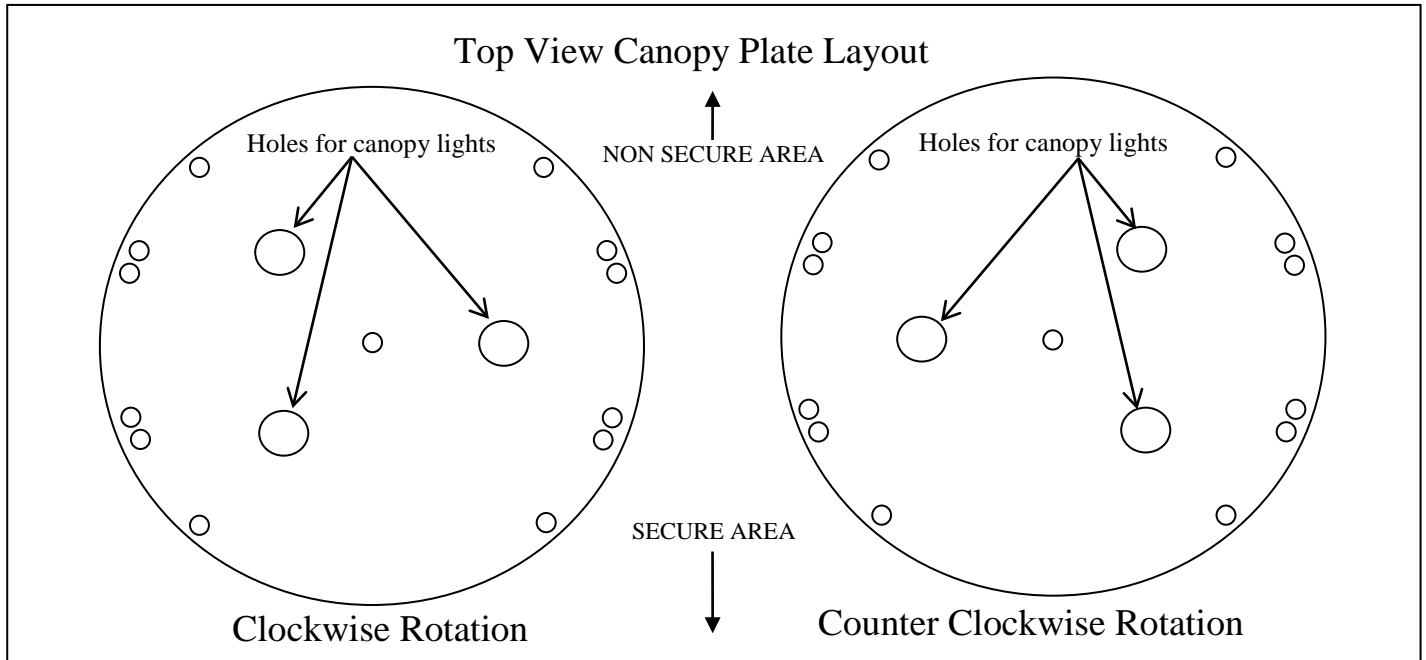

- 3.3 Allow canopy plate to come to rest on top of the cage panels with the support rods extending up through the holes
- 3.4 Place  $\frac{3}{4}$ " washer and nut on the rod tops (do not tighten)
- 3.5 If necessary shim cage panels in order to make turnstile level and square
- 3.6 Let the cage panels and the canopy set overnight so the epoxy anchor can cure

## 4. ROTOR INSTALLATION & BARRIER INSTALLATION

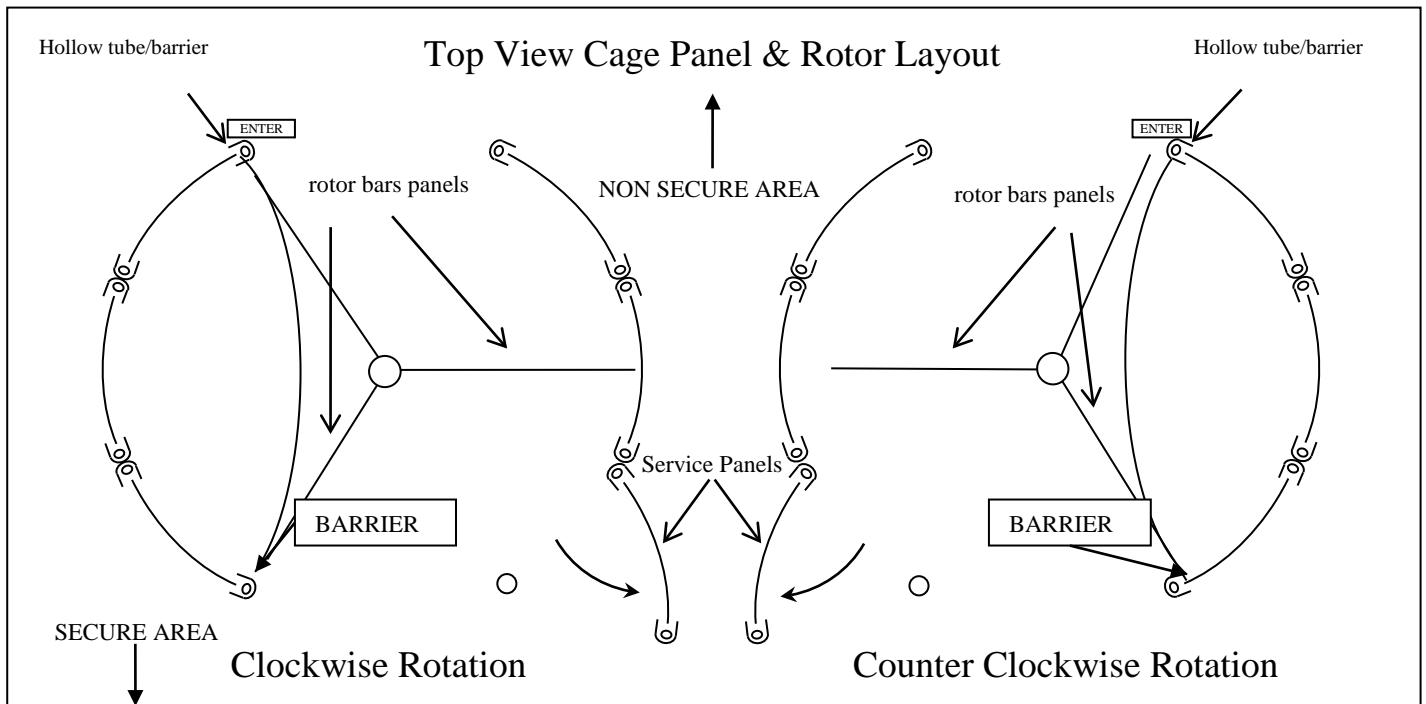

- 4.1 Anchor the bearing block down.
- 4.2 Place load runner bearing with 1 1/4 " hex inside the rotor bottom.
- 4.3 Move rotor onto bearing block.
- 4.5 Turn rotor into position as shown above
- 4.6 Place control head from on top of canopy into the rotor. Bolt down using 3/8" nuts washers & lock washers. Also tighten split pivot coupling onto 1 1/4" shaft.
- 4.7 Barrier consists of 2 arcs. Using 10/24" by 1 1/2" long button head screws, bolt arcs onto yokes. Holes are pre drilled.

## INSTALLATION OF THE CANOPY WRAP

- 4.1 There are two (2) canopy wraps for each turnstile, one for each side of the wall. Fit canopy wrap as shown below:

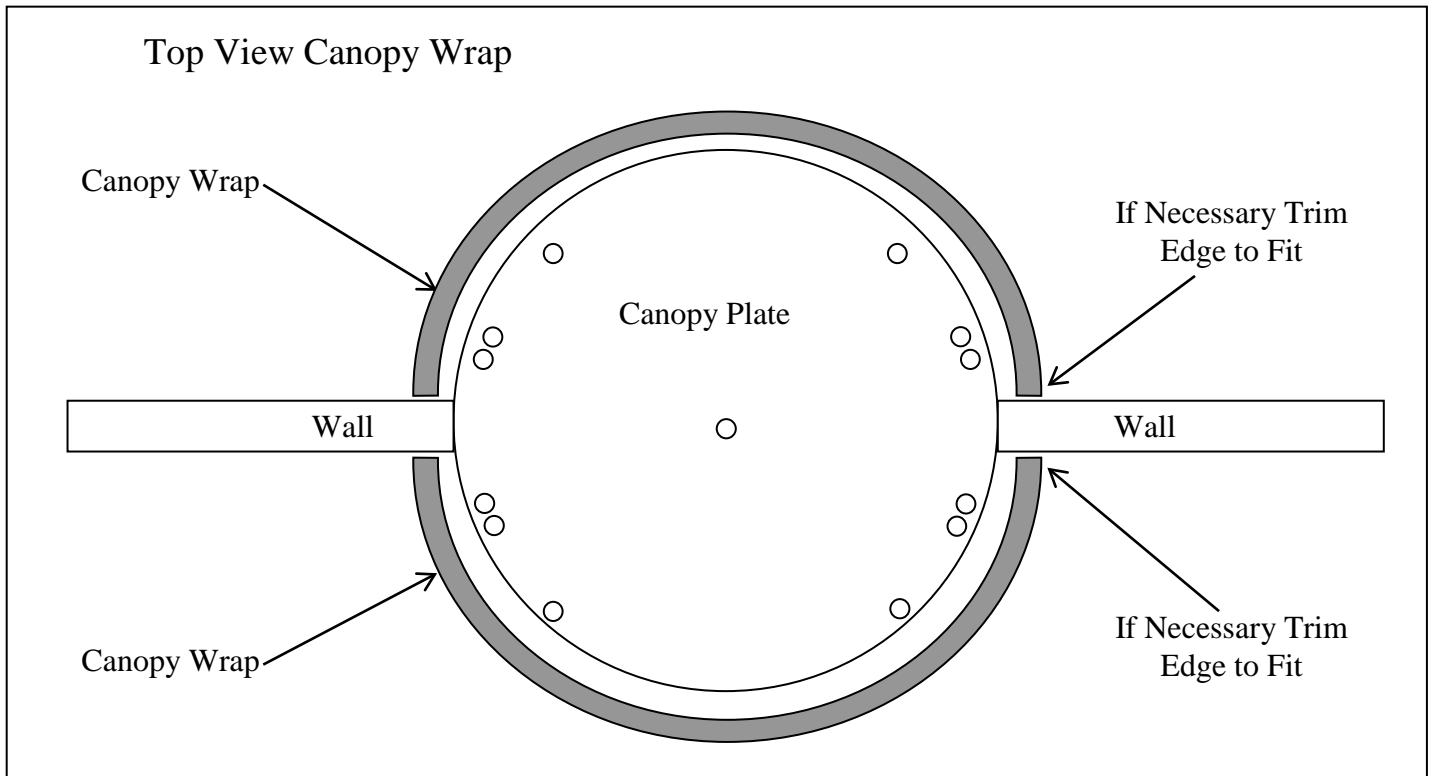

- 5.2 Secure canopy wrap to the base of the canopy plate every 25" – 27" (1" up from the base of the canopy wrap) using 10-32 flat head machine screws.

## 6500 Series Control Head Mechanical Information

All of our turnstiles and ADA gates operate with a mechanism called the 6500 series control head. This sturdy and easy to maintain drive for the turnstile has replaced all previous model control heads. It is adaptable to any existing turnstile and comes with each new turnstile purchase. This control head can be configured in multiple ways to accommodate the security requirements of each individual job site.

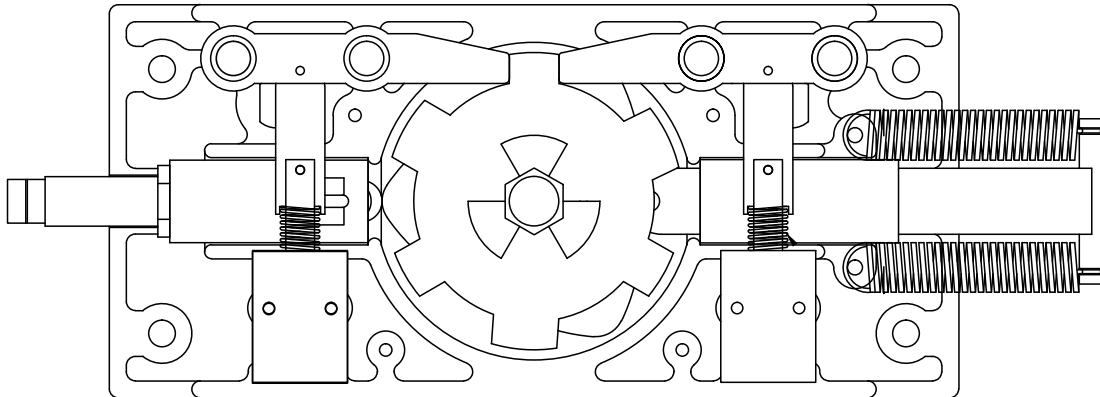

*An internal view of an electronically controlled two way 6500 series control head.*

While the head can be configured for mechanical (no electronics) operation, the turnstile's security potential is reached in the case of an electronic two way control head. In this instance, each rotational direction is independently unlocked. Configured properly, this control head will allow for one rotation per valid entry request. Our anti-backup cams are designed so that it is impossible to become trapped within the turnstile when properly installed.

Each control head comes preconfigured to your specific needs based off of a directional sheet that is filled out before shipment. The heads are delivered pre-wired, tested and adjusted to our factory recommendations. Installation is simple: connect inputs from access control devices into the logic controller and plug the unit's power supply into a 100-240 VAC (single phase) receptacle. The power supply will automatically set itself to function on your local voltage and convert it to 24VDC.

TOP CASTING REMOVED

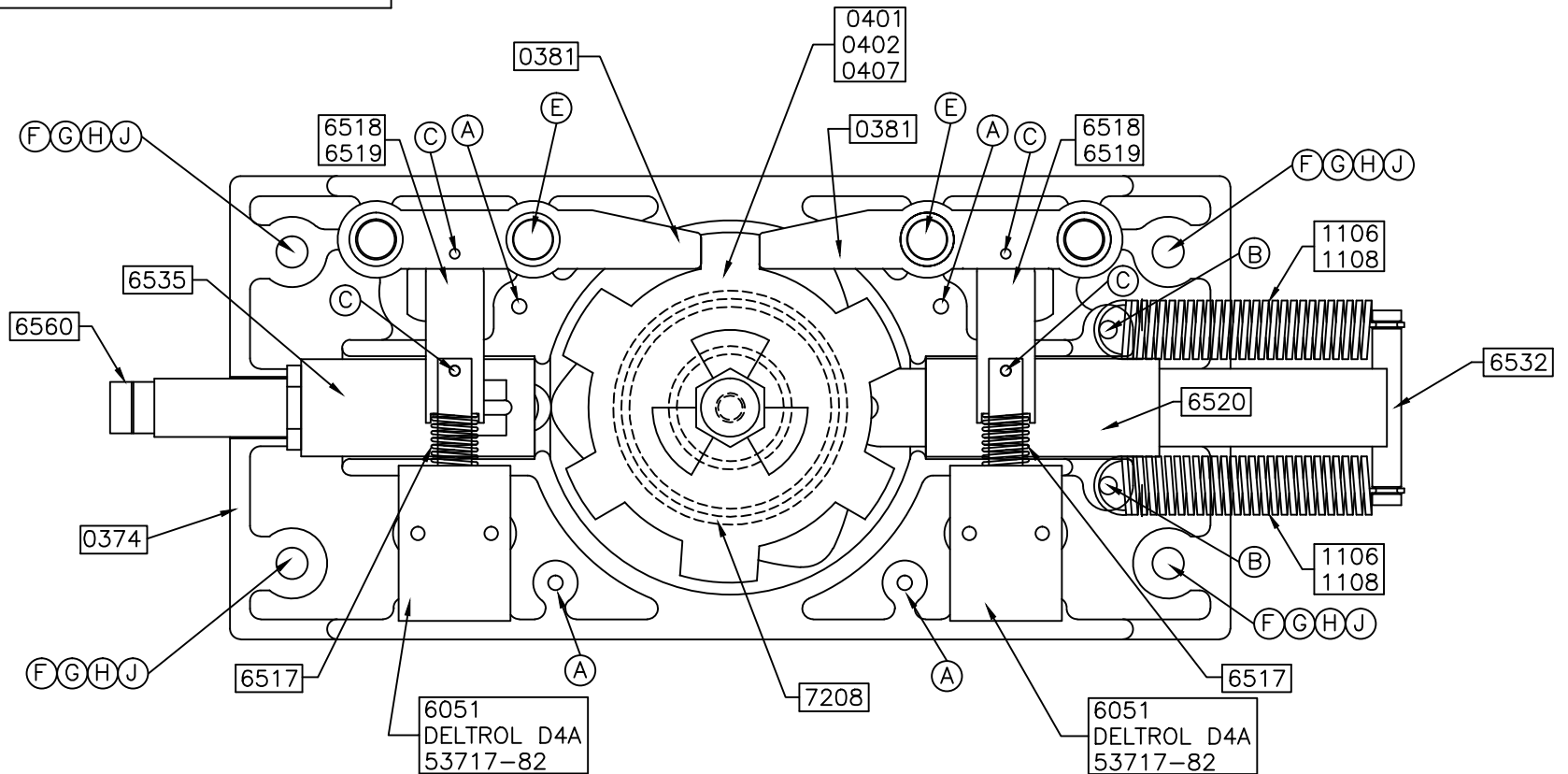

ALL ELECTRICAL COMPONENTS UL CERTIFIED







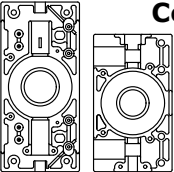
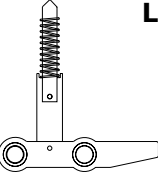
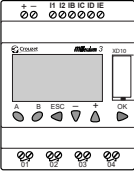
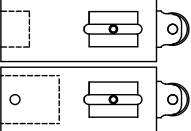
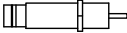
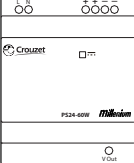

6500 SERIES CONTROL HEAD BOTTOM ASSEMBLY

NOTE:  
ALL WIRE AWG 18 GAUGE 300 VAC  
UL 1007/1569

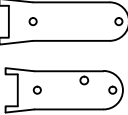
SYM	QTY	DESCRIPTION
(A)	4	1/4-20 x 1" SOCKET HEAD
(B)	2	1/4"φ x 1 1/4" SPRING PIN
(C)	4	1/8"φ x 5/8" SPRING PIN
(E)	2	1/2"φ X 2 1/4" DOWEL PIN

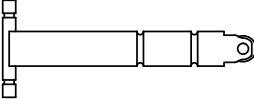
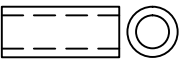
WAIST HIGH UNITS		
(F)	4	5/16 x 1-1/2" SS CARRIAGE BOLT
(G)	4	5/16 SS FLAT WASHER
(H)	4	5/16 SS LOCK WASHER
(J)	4	5/16 SS HEX NUT

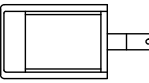
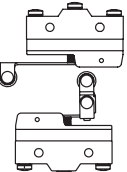
FULL HEIGHT UNITS		
(F)	4	3/8" x 1-1/2" SS CARRIAGE BOLT
(G)	4	3/8 SS FLAT WASHER
(H)	4	3/8 SS LOCK WASHER
(J)	4	3/8 SS HEX NUT

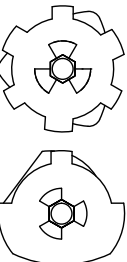
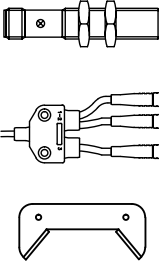
 <p><b>Control Head Castings</b> 0373 - Bottom Casting 0372 - Top Casting</p>	 <p><b>Locking Bar Assemblies</b> 0382 - Fail Open Assembly 0383 - Fail Lock Assembly</p>	 <p>0740 - Logic Controller (XD10)</p>
 <p><b>Shock Housing Assemblies</b> 6535 - WH/427/430/T80/ADA 6541 - 439/448/P60/HD</p>	 <p><b>Hydraulic Shock Absorbers</b> 6560 - WH/427/430/T80/ADA 6561 - 439/448/P60/HD</p>	 <p>0750 - 24VDC Power Supply (60 W) w/ NEMA 5-15 Drop Cord</p>
 <p>0381 - Locking Bar Casting w/ Oil Impregnated Bushings</p>	 <p><b>Locking Bar Linkages</b> 6519 - Fail Open 6518 - Fail Lock</p>	 <p><b>Solenoid Springs</b> 6510 - Fail Open Spring 6016 - Fail Lock Spring</p>
 <p>6532 - Index Pin</p>	 <p>6520 - Index Pin Tubing</p>	 <p><b>Indexing Springs</b> 1106 - Waist High (Light) 1108 - Full Height (Heavy) 07 - ADA (Extra Heavy)</p>
 <p>6051 - Solenoid Deltrol D4A53717-82</p>	 <p><b>Limit Switches</b> 2180 - Standard (Z-15GW2-B7-K) 1700 - One Way (BZ2RW825-A2)</p>	 <p><b>Limit Switch Cams</b> 2267 - Standard 2268 - ADA 2269 - One-Way</p>
 <p><b>Control Head Bearings</b> 7208 - Bottom Casting (6007RSNR) 1641 - 1" ID for HD Top Castings &amp; All Pre-2018 Tops (1641-2RSNR) \$ 1640 - 7/8" ID for Standard Duty Top Castings (1640-2RSNR)</p>	 <p><b>Cam Assemblies</b> 0401 - 427/430/T80/WH (7/8 Hex) 0407 - 439/448/P60/HD (1.25" Hex) 0402 - ADA (Must specify model)</p>	 <p><b>Proximity Sensor &amp; Accessories</b> 7211 - 24VDC PNP Prox. Sensor w/ M12 Connector (Sick 1040763) 0766 - 3 Branch M12 Splitter 6589 - Turnstile Prox. Bracket w/ 3x Mounts - LH, RH &amp; Home</p>

## 6500 Series Control Head Configurations

The 6500 Series Control Head can be configured in a number of different ways. All units operating with the 6500 Series Control Head self-center with a spring driven indexing pin and hydraulically shock to the home position to prevent damage or injury.

Various configurations are available to suit the needs of any environment. These include:

**Manual both ways:** Unit rotates freely in both directions. This unsecured configuration is used as a means to direct traffic through one area. Full height turnstiles can be also be purchased with an out of service lockout bar which would allow the end user to lock the turnstile with a standard pad lock.

**Manual one way:** Turnstile rotates in one direction but not the other. This is often used for egress only areas.

**Electronic one way with free exit:** Unit rotates freely in one direction but requires some form of access control in the other. This is a typical installation in many facilities that want to control who is entering but want egress to be free flowing.

**Electronic one way with no exit:** Turnstile is locked in both directions at all times, but in one direction can be unlocked with access control. Typically, this would be installed in scenarios where there is an alternate means of exiting the facility.

**Electronic two way:** Turnstile requires access control for both entering and exiting a facility. This configuration offers the highest level of security and also flexibility for installations.

**Fail lock:** Upon power failure, an electronically controlled direction would remain locked. This offers a high level of security but typically is not a good idea for egress unless alternate methods of exiting are available. Unless equipped with key overrides, this is can be easily converted to fail open by ordering alternate parts. This is also known as fail secure.

**Fail open:** Upon power failure, an electronically controlled direction would remain open. This is the most common configuration as it allows for secure access controlled passage in normal situations but in power outages it free wheels. Unless equipped with key overrides, this can be easily converted to fail lock by ordering alternate parts. This is also known as fail safe.

**Key overrides:** This option is available on either electronic or manual two way models. It can allow for a quick reconfiguration of free flowing passage or locking in either direction. The key override option is not intended for constant every day use. Should you require an additional lock-down feature on your turnstile, a better option (on a full height turnstile) is an out of service lockout with a standard pad lock. Note that the key override option makes conversion between fail lock and fail open very difficult to accomplish and also may not be available for some turnstile or gate models.



## 6500 Series Control Head Locking Bar Information

The 6500 Series Control Head is built to order based on a direction set up sheet sent with each quote. This sheet defines how each direction of passage functions.

Direction 1 is defined as clockwise rotation on a full height or with the cabinet on the right for waist high. Direction 2 is defined as counter-clockwise rotation on a full height or with the cabinet on the left for waist high.

Possible configurations include: no passage, free passage (manual), fail lock and fail open. Fail lock and fail open are not field reversible without additional components.

“No passage” directions include a fail lock locking bar assembly as well as an unwired solenoid. This adds the appropriate parts to the control head to prevent it from rotating in that direction.

“Free passage” (or manual) directions remove the solenoid and locking bar assembly, allowing the cam to spin freely.

Each direction has a pair of holes on the locking bar and control head casting. These holes act as pivot points for the locking bar casting. The inner holes are fail lock and outer holes are fail open. A .5” dowel pin slides through the entire assembly to hold everything in place.

Alternate linkages and springs are needed to convert a direction’s power failure status.

If optional key overrides are included, it becomes much more difficult to re-arrange the configuration. Typically it is best to send the control head into the factory to reconfigure any key override equipped head to ensure everything is done correctly.

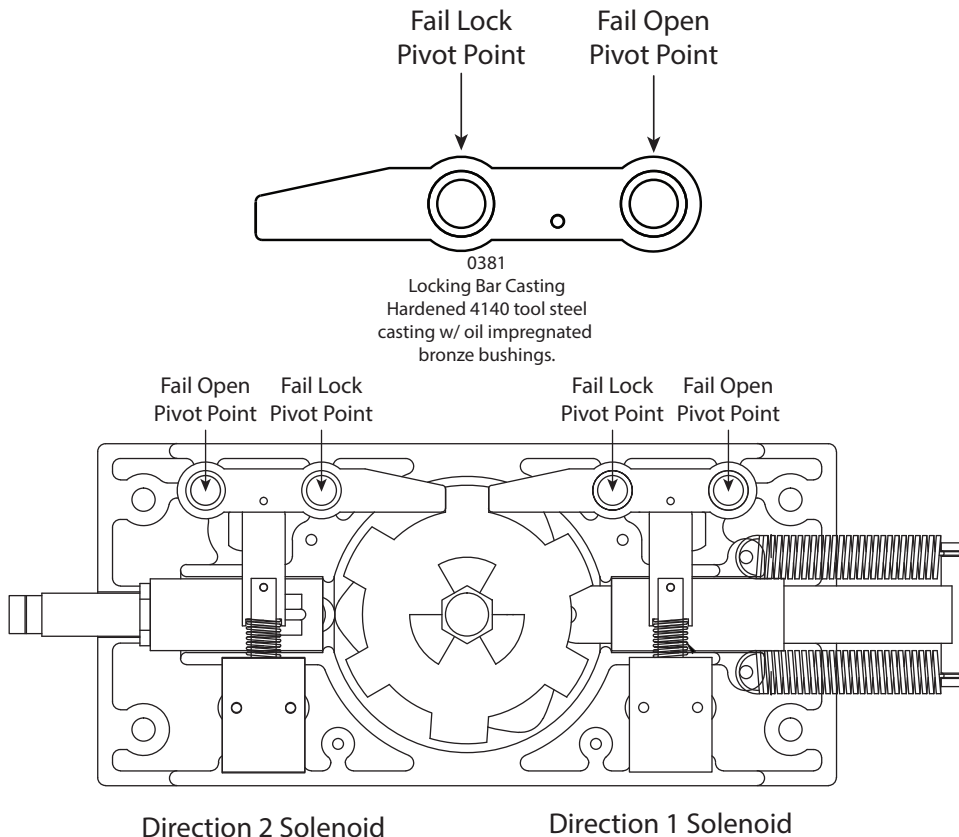

## 6500 Series Control Head Locking Bar Information (Continued)

The 6500 Series Control Head can be reconfigured from fail lock to fail open and vice versa. Extra components are required to do so.

If a control head has key overrides, we suggest sending it in for factory reconfiguration.

Locking bar assemblies are held together with 1/8" spring pins. Extracting these pins and reinstalling them can be tricky, so for convenience we also offer entire locking bar assemblies.

Replacing an entire locking bar assembly is simple, punch the .5" dowel pin from the pivot point through the head casting (via a small hole in the bottom casting for this purpose), pull out the old locking bar assembly and replace it with the new one.

If changing from fail lock to fail open or vice versa, install dowel pin in alternate hole.

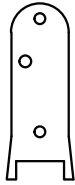

**6518**  
Fail Lock Linkage  
These have an approximate length of 2.25" and also include an extra hole the key override option.



**6010**  
Fail Lock Solenoid Spring  
These look the same as the fail open, but are actually much lighter in force  
Wire diameter is .032"  
This spring was also used on the 6100 Series Control Head.

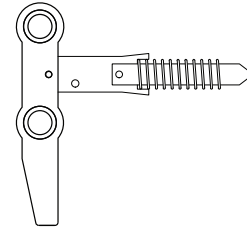

**0383**  
Fail Lock Locking Bar Assembly  
Includes locking bar casting w/ oil impregnated bushings, solenoid spring, locking bar linkage, and solenoid plunger.



**6519**  
Fail Open Linkage  
These have an approximate length of 2.5" and do not have the extra hole for the key override option.



**6510**  
Fail Open Solenoid Spring  
These look similar to fail lock, but are actually stronger in force.  
Wire diameter is .041".

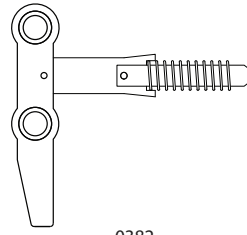

**0382**  
Fail Open Locking Bar Assembly  
Includes locking bar casting w/ oil impregnated bushings, solenoid spring, locking bar linkage, and solenoid plunger.

Make sure solenoid spring is between alignment tabs on linkage or the assembly may bind when pivoting.

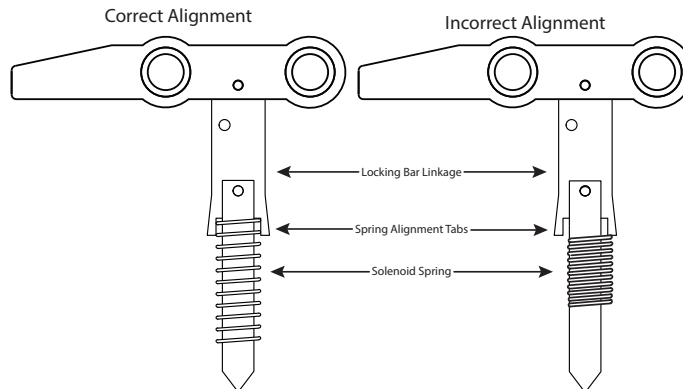

## 6500 Series Control Head Hydraulic Shock Information

The 6500 Series Control Head utilizes a spring loaded index pin for auto-centering the cam while a hydraulic shock offers counter resistance to slow the rotation down.

Set properly, the shock will allow a turnstile or gate to self-center while rotating smoothly without slamming.

Some turnstile models use a different shock than others. Waist highs and smaller full heights use a .75" diameter shock (Enidine brand) while larger full heights use a 1" diameter shock (ACE Controls brand).

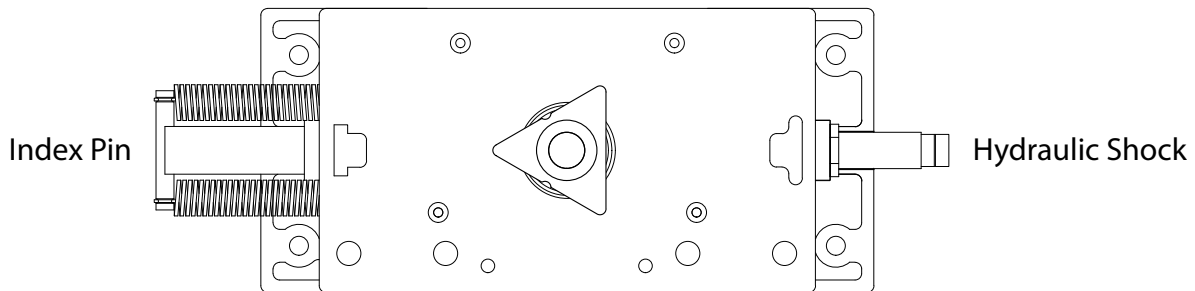

### Enidine Brand Shocks:

#### Setting:

Loosen the set screw on the head of the dial and turn the knob. The dial can be set between 0 and 8. The higher the number, the stronger the shock is. Tightening the set screw can alter the shock strength so a good habit is to loosen the set screw, turn the dial, tighten the set screw then test your setting. Repeat until satisfied.

#### Replacement:

Thread the new shock into the shock housing as far as it will turn while the cam is in the home position. Once it bottoms out, thread the shock back out 1.5 - 2 turns until the numbers on the dial are facing upright. Some models may require an additional turn or two outward if the arm does not self center on even the lowest setting.

### ACE Controls Brand Shocks:

#### Setting:

Loosen the set screw located on the end of the shock itself before the dial. The dial can be set between 0-8 and the set screw acts as indicator for the dial. The lower the number, the stronger the shock is.

#### Replacement:

Thread the new shock into the housing as far as it will turn while the cam is in the home position. Once it bottoms out, thread the shock back out 1.5-2 turns until the set screw pointer is facing upright. Fasten the shock into the housing by snugging the 1/4-28 set screw into the bronze housing (snugly, but do not over tighten or the brass might start to tare).

**Failure to turn the shock back out after threading it in all of the way will likely cause the part to wear out very quickly.**

## 6500 Series Control Head Electrical Information

Each electronic control head comes with a power supply, a programmable logic controller (PLC), limit switches (or optionally, proximity sensors) and solenoids. For safety purposes, it is recommended that you read all literature on the electrical components before attempting to install the control head into a turnstile.

The 6500 Series Control Head is on the third generation of electronic components. The new XD10 logic controller is a direct replacement of both the 0789 control board and 6789 (Keyence KV-16DR) logic controller.

The latest enhancements provide a broader temperature range for outdoor installations (-4 to 131F) as well as a user friendly text based interface with a daylight visible display. With this also comes some new features such as on board testing buttons, turnstile statistics / information, etc.

While the wiring may be different, there are very few exceptions to when this board is compatible with installed products. If an installation has the old 0789 circuit board (PCB) and has the optional proximity sensor upgrade, new proximity sensors will need to be purchased. This is because the 0789 board had NPN inputs while the XD10 (and the KV-16DR) have PNP inputs.

The new PLC still requires relay contact closures for inputs just like all previous generations, so any installation is compatible in one way or another. If assistance is needed with understanding how to convert the wiring from access control to the new logic controller, please view this manual or call our technical support department for assistance.

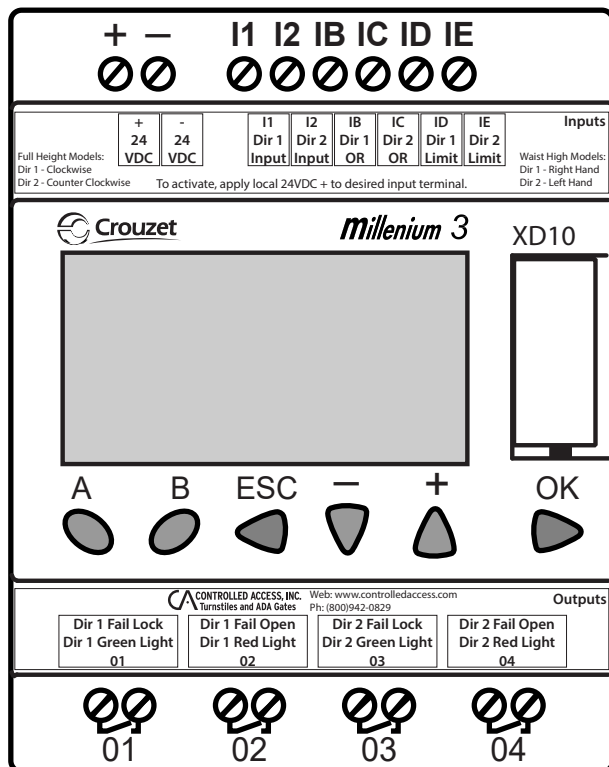

XD10 Logic Controller  
0740

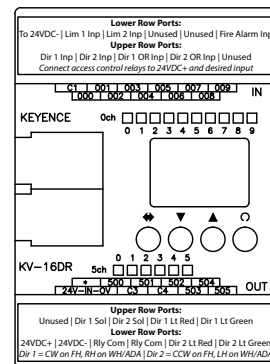

KV-16DR Logic Controller  
6789

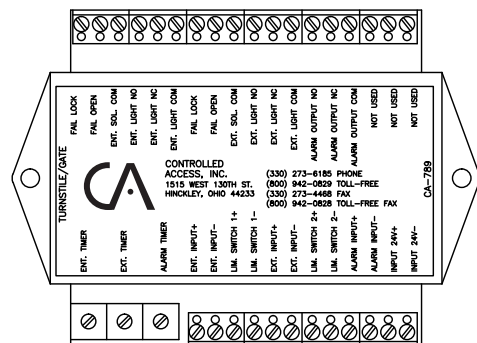

Control Board  
0789

# 6500 Series Control Head w/ XD10 Controller Standard Wiring Diagram

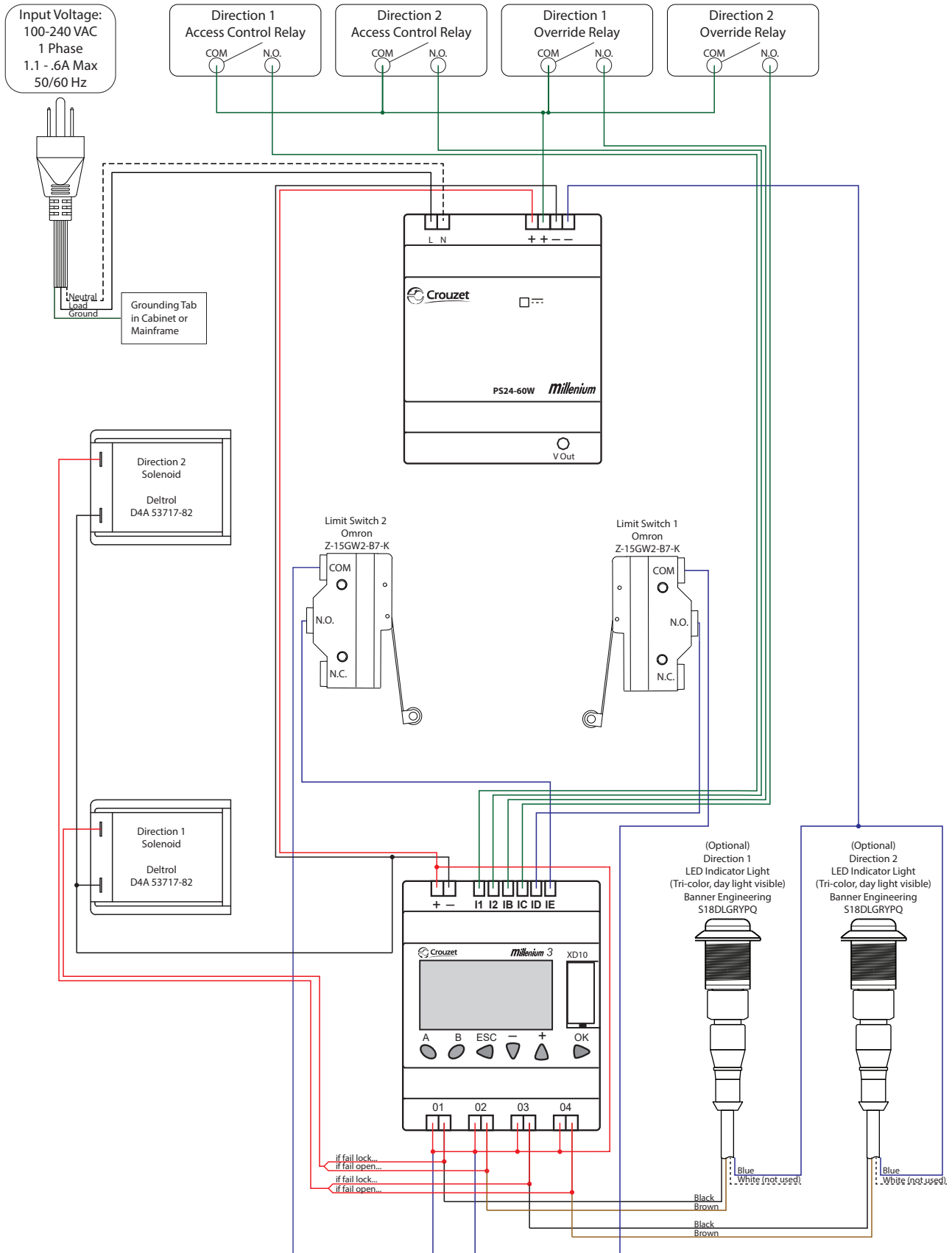

# 6500 Series Control Head w/ XD10 Controller Standard Wiring Legend

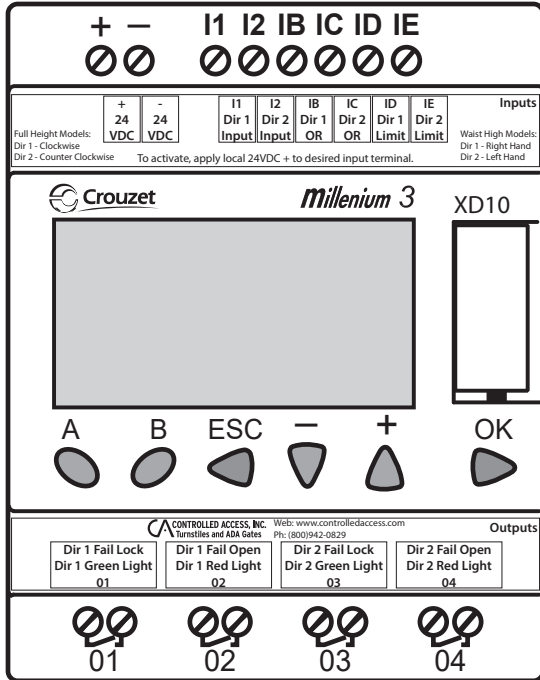

## General definitions:

- Direction 1** - Clockwise on full height turnstiles or cabinet on right for waist high turnstiles & ADA gates.
- Direction 2** - Counter clockwise on full height turnstiles or cabinet on left for waist high turnstiles & ADA gates.
- Limit** - A switch or sensor designed to detect rotation and lock the unit after a rotation.
- Fail Lock** - Upon power failure, the direction is designed to remain locked. Also known as Fail Secure.
- Fail Open** - Upon power failure, the direction is designed to remain opened. Also known as Fail Safe.

Each unit is built to order, preconfigured to function as specified at the time the order is placed. Some or all of the information listed may not be relevant to the installation.

Inputs are triggered with local 24VDC + (also known as PNP or sourcing). Connect relay output from access control device to turnstile by terminating 24VDC + to relay common and the desired input to the relay's normally open terminal.

Be sure to disconnect power before wiring the board for safety.

Note: directional status outputs (lights) are unaffected by optional key overrides as the override occurs outside of the logic controller.

## Input descriptions:

- 24VDC +** Positive output from the 24VDC power supply connects here.
- 24VDC -** Negative output from the 24VDC power supply connects here.

- I1 - Direction 1 Input** - Unlocks direction 1 for either one rotation or until the timer expires. Standard access control should terminate here.
- I2 - Direction 2 Input** - Unlocks direction 2 for either one rotation or until the timer expires. Standard access control should terminate here.
- IB - Direction 1 Override** - Holds direction 1 unlocked for duration of contact closure. Mainly for fire alarms and other temporary overrides.
- IC - Direction 2 Override** - Holds direction 2 unlocked for duration of contact closure. Mainly for fire alarms and other temporary overrides.
- ID - Limit 1 Input** - Cancels Direction 1 activation if triggered before timer expires, re-locking the unit after one rotation.
- IE - Limit 2 Input** - Cancels Direction 2 activation if triggered before timer expires, re-locking the unit after one rotation.

## Output descriptions:

All 4 relay outputs have individual commons. 24VDC+ is distributed to each relay common to operate the turnstile. It is OK to add extra wires to these relay commons to distribute voltage to other devices.

- 01 - Output 1** - Dual purpose output for Direction 1. If the direction is fail lock, it's solenoid would connect here. If equipped with an indicator light, the green leg would connect here. Output switches from OFF to ON when directional input is triggered.
- 02 - Output 2** - Dual purpose output for Direction 1. If the direction is fail open, it's solenoid would connect here. If equipped with an indicator light, the red leg would connect here. Output switches from ON to OFF when directional input is triggered.
- 03 - Output 3** - Dual purpose output for Direction 2. If the direction is fail lock, it's solenoid would connect here. If equipped with an indicator light, the green leg would connect here. Output switches from OFF to ON when directional input is triggered.
- 04 - Output 4** - Dual purpose output for Direction 2. If the direction is fail open, it's solenoid would connect here. If equipped with an indicator light, the red leg would connect here. Output switches from ON to OFF when directional input is triggered.

## Indicator light information:

- Green Light** - An indicator to inform pedestrians that they are allowed to pass through the unit. Uses black output wire from light's cable.
- Red Light** - An indicator to inform pedestrians that the unit is locked or that pedestrians require credentials to enter. Uses brown output wire from light's cable.

As a side note, indicator lights purchased from Controlled Access, Inc. can also be wired to glow **yellow**. If desired, this can be used instead of red with the unused white wire on the light's cable to indicate to pedestrians they require credentials to enter. This is especially handy for multi-lane installations in which some directions are "no passage" instead of "controlled passage". Likewise, green lights can also be wired to a red light output to constantly glow green to indicate "free passage".

## 6500 Series Control Head w/ XD10 Controller Standard Turnstile Settings

The XD10 logic controller on the 6500 Series Control Head has a text based menu screen to adjust settings and view statistics of the turnstile. Pressing the A button will cycle to each of the screens available on the device. Pressing B from any screen listed will return to the Home Screen.

### Home Screen

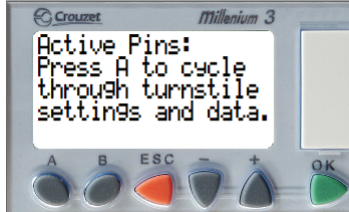

This screen is at the start of the menu cycle. The top section will give a read out of inputs that are currently receiving voltage. The display will return to this screen after cycling through all windows, 5 minutes of inactivity or pressing the B button.

### Timer Values Screen

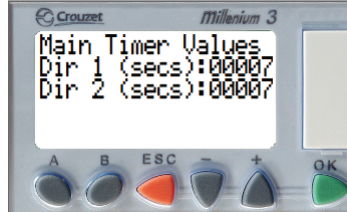

This screen allows for the each directional timer to be modified. Select which value you wish to edit by pressing the + & - key. Press OK to select the value then press + or - to modify. Save by pressing the OK button again. Each timer can have a value of 1 - 60 seconds. The timer will be canceled upon rotation of unit.

### One-Shot Timers Screen

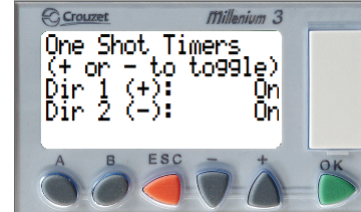

This screen allows for the two one-shot timer settings to be enabled or disabled. This setting prevents access control from holding open a direction on the standard direction inputs. Toggle Direction 1 by pressing + and Direction 2 by pressing -. This should be set to "On" in almost every installation.

### Swipe Queue Screen

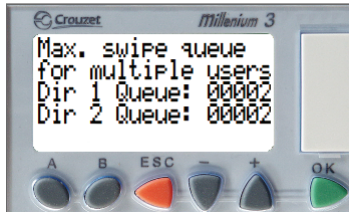

This screen defines the maximum number of access control requests the unit will allow in queue. Each value can be set from between 1 (for maximum security) to 3 (for fast paced passage). The default is 2. The method to change these settings is the same as the Timer Values Screen.

### Direction 1 Counts Screen

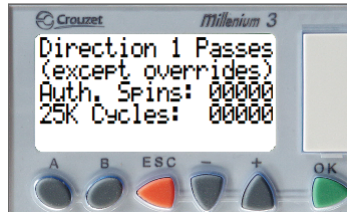

This screen gives statistics about how many times direction 1 was activated and cycled. Since there is a limit to how many counts can be displayed, after 25000 cycles the first counter resets and adds to the second counter.

### Direction 2 Counts Screen

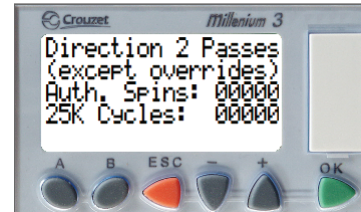

This screen gives statistics about how many times direction 2 was activated and cycled. Since there is a limit to how many counts can be displayed, after 25000 cycles the first counter resets and adds to the second counter.

### General Info Screen

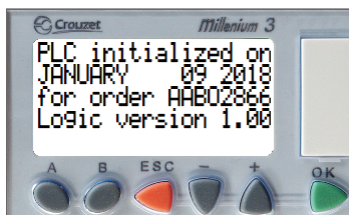

This screen displays when the PLC was initiated, the order number it was activated for (except for any revision suffixes which are not needed for order lookup), and the PLC software version.

### Testing Mode Screen

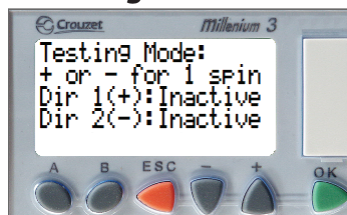

While this screen is active, the unit can be tested with push buttons to simulate access control inputs. See the page dedicated to testing for more information.

### Factory Setup Screen

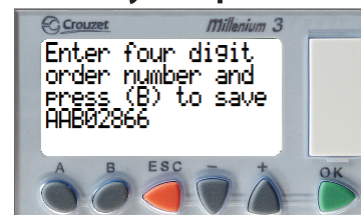

This screen should only appear when first set up in the factory or if something occurs to totally reset the logic controller. If this manages to occur and the order number (if known), enter it as a value then press B to save.

## 6500 Series Control Head w/ XD10 Controller Standard Turnstile Testing

The XD10 logic controller on the 6500 Series Control Head can be activated by contact closures between 24VDC+ and the relevant input. New technology allows for simpler on-board testing as well. To diagnose issues with the unit, press A on the keypad to cycle between screens until the testing mode screen appears.

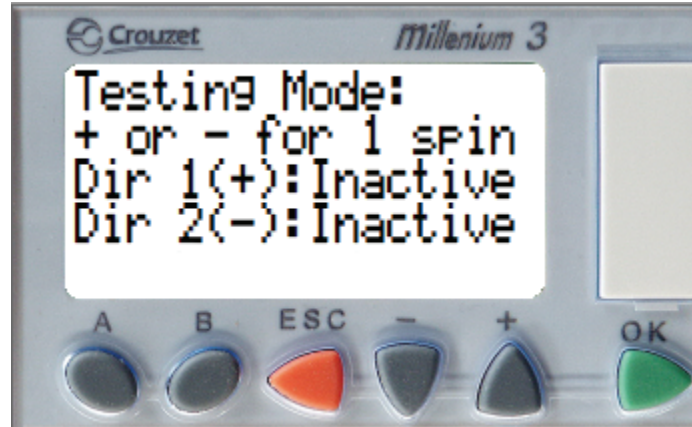

Testing mode simulates valid access control inputs based on the settings defined on the other menu screens. The unit should unlock for the duration of the directional timer or until the unit is rotated. If the button is pressed twice, it should allow two rotations or time out based on the multi-swipe setting. If the button is held and the one shot timers are disabled, the unit will continue to remain open until the button is released and another rotation or timeout occurs.

With the testing mode screen open, press and release + to activate in direction 1. The unit should unlock and allow one rotation. If the unit successfully functions this way, repeat the same for direction 2 by pressing the - button.

If everything is functioning properly from the menu test but not with access control, either access control is not connected properly, is normally closed instead of normally open, or is not properly configured. Contact a security integrator for assistance with help with the access control system.

If the unit successfully unlocks but does not re-lock upon rotation, try to manually trigger the appropriate limit switch for the direction that is not working correctly. If this helps, it is likely that the limit switch is not properly being triggered by the limit switch cam. Either adjust the height of the limit switch cam or tweak the lever on the limit switch a bit closer to the limit switch cam's tip.

If the unit does not successfully re-lock after manually triggering the limit switch, ensure that it is wired properly. Return to the home screen and press / hold the limit switch. If the switch is being held but the "Active Pins" display does not include the switch being held, it may be necessary to replace the switch. Note that there is a short delay from when the switch is triggered to when the display will register it as active, however this is normal.

If there are other issues with operation, check out the troubleshooting guide for additional diagnostic procedures or call Controlled Access, Inc. for assistance.



## 6500 Series Control Head Limit Switch Information

Electronically controlled 6500 Series Control Heads utilize limit switches (or optionally, proximity sensors) in order to detect rotation. Depending on the type of unit (turnstile or ADA gate), the limit switch for a direction may be on the left or the right hand side of the control head.

### Turnstile Control Head

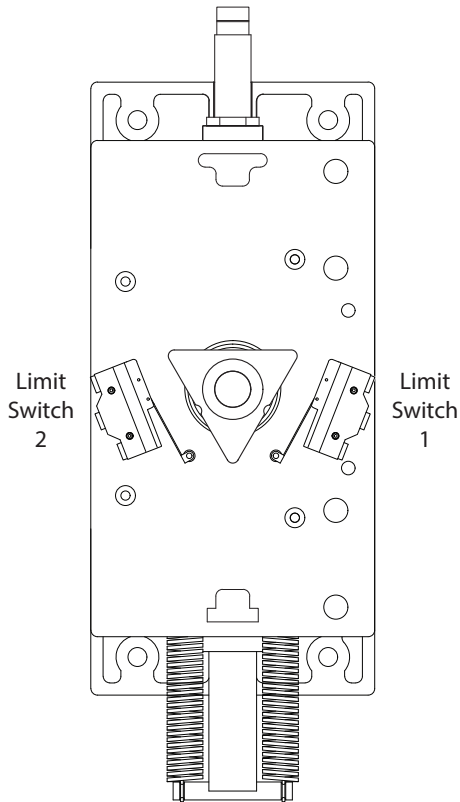

Turnstile control heads use a triangular shaped limit switch cam. One point of the triangle needs to be facing the index pin (bar with two springs) when the cam is in the home position. The two indents in the sides of the triangle are for jiggling purposes. It does not matter which point is facing to the springs.

The limit switch for direction 1 is on the right and the limit switch for direction 2 is on the left. In this configuration, the first limit switch triggered does not affect the unit. The second switch triggers after the half-way point of the rotation, which draws in the solenoid. This allows the rotation to go to home but prevents the rotor from backing in the other direction.

### ADA Gate Control Head

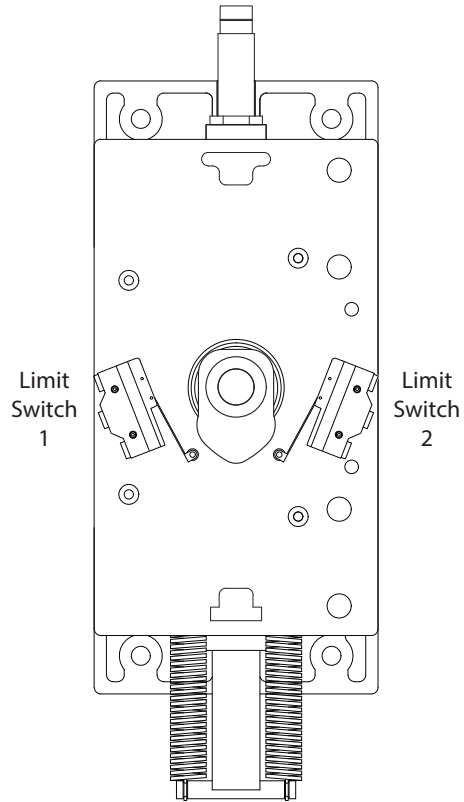

ADA Gate control heads use an oblong lobe shaped limit switch cam. The point of the lobe needs to be facing the index pin (bar with two springs) when the cam is in the home position.

The limit switch for direction 1 is on the left and the limit switch for direction 2 is on the right. In this configuration, the limit switch relevant to the swing is triggered after the cam leaves home position, which re-engages the locking bar. The cam is still free to move until it swings back to the home position.

Options and configurations may alter the quantity or layout of the limit switches. Some examples of this would be electronically controlled one direction turnstiles, turnstiles with counters and turnstiles equipped with home position switches.

## Maintenance & Cleaning

To ensure long life on any turnstile, the following maintenance is recommended. Note: these figures are assuming a maximum 75000 passages per year. Turnstiles with heavier traffic should be maintained more frequently.

### Annual Servicing

- Secure all nuts & bolts throughout each model. This includes concrete anchors, carriage bolts holding together mainframes, and the bolts holding the control head assembly together.
- Remove the index pin assembly from the control head by disconnecting the two extension springs & apply white lithium grease. Use 3-in-1 oil on the index pin roller.
- If the unit is a High Security series full height turnstile, add grease to the rotor's roller bearing by utilizing the grease fitting fastened into the bottom of the rotor.

### Bi-annual Servicing

- Disassemble the control head by removing the 4x socket head cap screws holding the top casting to the bottom casting (and the triangular limit switch cam if equipped).
- Clean any loose debris / grease from the inside of the casting.
- Inspect internal components for wear and replace as needed.
- Apply 3-in-1 oil to the bronze bushings on the locking bar assemblies and shock piston.
- Apply white lithium grease to the shock piston where it enters the bronze housing.
- Reassemble the control head assembly, using removable strength (typically blue) thread sealer (such as Loctite 243) on the head bolts to ensure the assembly stays together.

### Cleaning

- Galvanized surfaces can be cleaned with soap and water. The finish may dull over time, but this is normal.
- Powder coated surfaces should be cleaned with a non-abrasive cleaner such as Formula 409. Inspect finish for chips and touch up as needed or the exposed steel may rust.
- Stainless steel surfaces should be polished with a stainless steel wax or polish. Contrary to common belief, stainless steel is not rust proof. Exposure to certain chemicals and harsh environments such as ocean air or chemical plants may cause surface corrosion. Minor discoloration can be removed with a rust penetrating product (such as PB Blaster) along with non-scratching scouring pads. Severe cases of contamination may require the use of specialty products. We have had great success with products such as Stellar Solutions' Citrisurf 2310 Rust Remover and Passivation Solution.
- The decorative solid surface tops on our Executive models, Beacon models and some PassThru models should be polished with furniture polish (such as Scott's Liquid Gold Wood Cleaner). Allowing the product to soak into the material for a few minutes easily restores the surface's luster.
- Polycarbonate plastic should only be cleaned following the plastic manufacturer's recommendations. **DO NOT USE ANY PRODUCTS THAT INCLUDE AMMONIA OR OTHER HIGH PH PRODUCTS.** If the model purchased includes polycarbonate plastic, see the section of the manual dedicated to cleaning it (starting on the next page). Failure to use appropriate cleaning methods will cause aesthetic and structural damage to the plastic which will not be covered under the warranty.

Control heads can be removed from the turnstile and shipped to the factory at any time for repairs and maintenance. Please include contact information so we can call to discuss any issues your control head may have. Please note that any repairs that cost under \$500.00 will require a credit card payment before being returned.

## 6500 Series Control Head w/ XD10 Controller Troubleshooting

Symptoms	Causes	Solutions
Turnstile does not power up or logic controller's display cycles on and off.	Power supply is not receiving input voltage.	Verify outlet receptacle installed in mainframe / cabinet is operating correctly and that the power supply is plugged in.
	Power supply is not producing 24VDC voltage, but is receiving AC.	Remove + lead from power supply output. If output voltage resumes, there is a short circuit in the wiring. If not, the power supply is faulty. Replace power supply.
	Short circuit in the wiring as determined in previous step.	Refer to pages 13-15 for wiring information.
	Loose wiring from power supply to logic controller.	
	Short circuit in the wiring.	
	Solenoid(s) burnt out (will occur if main AC voltage is connected directly to solenoid).	If wiring is correct, try to disconnect the solenoids from outputs 01 - 04. If system stops cycling, replace faulty solenoid.
Solenoid tabs grounded out against control head casting after being reassembled from maintenance or reconfiguration.	Disassemble control head casting and flip solenoids so that the tabs with wires are facing away from the center of the control head casting.	
Turnstile powers up but does not respond.	Solenoid (-) wire(s) not properly terminated.	Ensure solenoid negative wires are properly terminated to 24VDC- input and that the 3 wire splice (if equipped) is properly crimped.
	Improper wiring from access control to logic controller.	Ensure one leg of access control output relay is connected to 24VDC + and the other to the desired input.
	Access control device malfunction.	Disconnect access control from logic controller. Perform testing procedures on page 16. If the turnstile works properly, contact manufacturer of access control device.

## 6500 Series Control Head w/ XD10 Controller Troubleshooting

Symptoms	Causes	Solutions
More than one person can get through turnstile.	Access control device output connected to override inputs.	Wire access control to I1 or I2 with one-shot timer enabled.
	Access control device output set too long.	This can be avoided by enabling the one-shot timers built into the logic controller program. If this is undesirable, ensure the output from the access control system is one second or less.
	Loose wiring to the logic controller from limit switches.	Refer to pages 13-15 for wiring information.
	Limit switches are broken.	Inspect limit switches for breakage, replace as needed.
	Control head requires maintenance.	Refer to page 18 for more information.
	Limit switches are missing the triangular top cam.	Adjust the top cam to the proper height and/or tweak the triggers on the limit switch. Refer to page 17 for more information.
People are becoming trapped inside of the turnstile (Full Height models)	Rotor was installed backwards.	Refer to page 4 installation for visual diagram on how to install rotor properly.
Turnstile only rotates 30 degrees.	Limit switches wired incorrectly.	Refer to pages 13-15 for wiring information and page 17 for limit switch placement.
	Limit switch cam is misaligned.	The top cam should have one point facing the control board. If this is not the case, readjust the top cam. Refer to page 17 for top cam information.
Unit remains unlocked until access control is presented.	Fail open / fail lock configuration is wired incorrectly.	Refer to pages 13-15 for wiring information.
Turnstile is slamming into the closed position.	Shock either needs adjusted or replaced.	Refer to page 12 for more information.
Turnstile is not centering properly.	Shock needs adjusted.	
		Binding in control head.
Turnstile seems to be binding mechanically.	Rotor is not plumb / turnstile body is not level.	

## 6500 Series Control Head w/ XD10 Controller Troubleshooting

Symptoms	Causes	Solutions
Unit remains locked after access control is presented until arm is pulled in.	Mechanical bind between locking bar and cam assembly (typically from unit being out of plumb or not level)	Remove locking bar assembly from control head (easiest way on non-key lock models is to punch out dowel pin pivot point from bottom side of head casting) and file down tip of locking bar to give clearance.
Turnstile rotating the wrong direction.	Improperly filled out direction sheet.	In some cases, the control head can be reconfigured in the field to operate as needed. Refer to pages 9-11 for information about how the control head operates. If needed, control heads can be returned to the factory for reconfiguration for a fee of labor plus parts (if required). Please contact us before returning a control head in this instance.
	Directional inputs wired incorrectly.	Refer to wiring legend on page 15 for direction port explanations.
Turnstile fails lock when needed to fail open or vice versa.	Improperly filled out direction sheet.	Refer to page 11 for more information. Additional parts will be required to convert operation. The control head can be returned for reconfiguration for a fee of labor plus parts (if required). Please contact us before returning a control head in this instance.
Unable to hold direction open to allow multiple people to pass through the turnstile.	Override wired to incorrect inputs.	Ensure the access control device dedicated to overriding passage is wired to the override input instead of the standard input for that direction.
	One-shot timers are enabled (on regular access control input).	Disable the one-shot timer settings on the logic controller. Be sure that your access control output is one second or less during regular secure operation or extra people may be able to pass through. Refer to pages 18-19.
Other problems.		Please contact us for any other issues.

## Proper Turnstile Usage

The 6500 Series Control head is easy to use. There are a few things that users should be trained on and informed of.

- In the case of an electronic turnstile, approach the unit and present access control credentials. Do not push on the arms of the rotor until after the access control device successfully unlocks the turnstile. A sturdy click sound will be heard from the main channel when the solenoid pulls the locking bar open.
- Note that the turnstile will not unlock if the rotor or arm is being pushed on before access control activates the solenoid. The unit should unlock once pressure is released but it is a better practice to wait until the unit is unlocked before pushing on the rotor.
- Once access has been granted, proceed through the turnstile immediately. Waiting too long could cause the rotor to time out mid-rotation, forcing the user to back out of the turnstile. There are timer settings for adjusting how long it takes for this to occur. The default time provided is 7 seconds. The reason for this is in case somebody swipes and walks away without passing through.
- Walk at a reasonable pace through the turnstile. Do not slam the rotor through the rotation. This can be unsafe and may cause unnecessary wear and tear to the control head.
- Try to be respectful of users wanting to pass through the opposite direction. Allow people who are waiting an opportunity to pass through the turnstile.
- Avoid rotation the rotor of a full height without being in the passage. This will cause the rotor to re-lock before you have a chance to pass through the turnstile.
- Piggybacking : More than one user trying to squeeze through the turnstile on one rotation should be avoided. Large bags and carts should be brought through an alternate means of entrance.

## Warranty Information

Seller warrants the goods against defective workmanship and materials provided that Buyer notify Seller within one (1) year after receipt by Buyer of the goods of any claim under this Warranty. The liability of Seller shall be limited to replacing or repairing defective goods returned by Buyer and delivered to the factory of the Seller, transportation charges prepaid.

Replaced or repaired goods will be redelivered freight repaid to the address of Buyer shown hereon. Except for the Warranty contained herein, there shall be no other warranties, such as warranties of fitness and merchantability or otherwise express or implied, written or verbal, and Seller shall not be liable for consequential damages in any event.

# Compact Switching Power Supply MS2 Series Instruction Manual

## Part Names and Functions

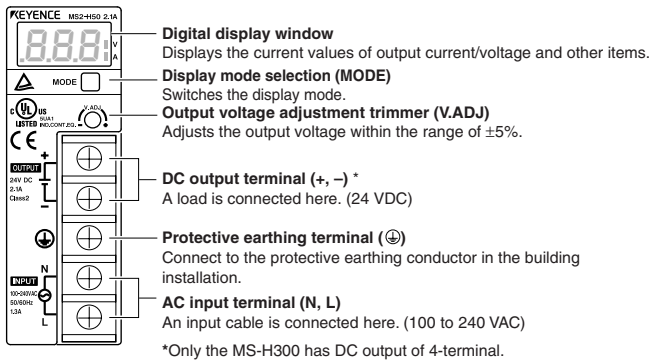

## Safety Precautions

### Danger

- Do not perform any electrical wiring while electric current is applied. Failure to follow this may result in an electric shock or fire.
- Be sure to connect the grounding cable. Failure to follow this may result in an electric shock or fire.
- Do not touch this unit within 1 minute after AC input is turned off. Failure to follow this may result in an electric shock.
- Do not modify or repair this unit. Failure to follow this may result in an electric shock, accident, or product failure.
- Do not touch any terminal of this unit while electric current is applied. Use the unit with the terminal cover installed to avoid an electric shock.

### Warning

- When this unit is used in a system that may cause a serious accident or damage if the unit fails, be sure to install a safety device.
- Pay attention to prevent foreign matter such as metal particles, dust, paper or wood chips from entering the inside of this unit. Failure to follow this may result in a fire or product failure.
- Do not touch any metallic part while electric current is applied or immediately after input is shut off. Failure to follow this may result in a burn due to a high temperature.
- If a failure or abnormality occurs while this unit is in use, immediately such off AC input and stop operation of this unit. Failure to follow this may result in a fire or accident.

### Caution

- Check that the AC input rated voltage of this unit is equal to the voltage of the AC power supply.
- Do not connect the AC power supply to the DC output terminals.
- Do not disturb the convection of air near the vent of the casing.

## Precautions for CE Markings

KEYENCE has evaluated the conformity of the MS2 Series with the requirements of the EMC Directives and Low-voltage Directives under the following condition, and confirmed that the MS2 Series meets these requirements. For the Low-voltage Directives, the MS2 Series has obtained certification from TUV Rheinland for the following standards.

### <Precautions>

#### ● EMC Directives (89/336/EEC)

- Applicable standard (EMI) EN55011, Group 1, Class A
- Applicable standard (EMS) EN61000-6-2

#### ● Low-voltage Directives (73/23/EEC)

- Applicable standard EN60950-1
- EN50178
- Overvoltage category II
- Pollution degree 2

- The MS2 Series is designed as a Class I Equipment. Be sure to connect the protective earthing terminal on the terminal block to the protective earthing conductor in the building installation.
- The MS2 Series is an open-type device. Be sure to install it in an appropriate enclosure rated as IP54 or better.
- Use the MS2 Series according to the derating conditions and the installation conditions described in this manual.
- The MS2 Series does not include a disconnecting device. Be sure to install a disconnecting device such as a circuit breaker in the building installation wiring.

## Precautions for UL Standards

The MS2 Series meets the following UL standards and has obtained UL and C-UL certification.

- Applicable standard UL508 Industrial Control Equipment  
 UL60950-1 Information Technology Equipment - Safety  
 CAN/CSA C22.2 No. 14-M95 Industrial Control Equipment  
 CAN/CSA C22.2 No. 60950-1-03 Information Technology Equipment - Safety
- UL File No. E195940, E242533
- UL category NMTR, NMTR7 / QQQQ2, QQQQ8

### <Precautions>

- Use wires that meet the following conditions for the terminal block. (tightening torque : 1.2 N•m)
 

Wire range	AWG#14-22
Wire Material	Copper wire only
Wire type	Stranded wire only
Temperature rating	60°C/75°C
- The MS2 Series is designed as a Class I Equipment. Be sure to connect the protective earthing terminal on the terminal block to the protective earthing conductor in the building installation.
- The MS2 Series is an open-type device. Be sure to install it in an appropriate enclosure rated as IP54 or better.
- Use the MS2 Series according to the derating conditions and the installation conditions described in this manual.
- The MS2 Series does not include a disconnecting device. Be sure to install a disconnecting device such as a circuit breaker in the building installation wiring.
- The output of the MS2-H50 is regarded as Class 2 output specified in NEPA70 (NEC: National Electrical Code) in the U.S.A. (UL Category: EPBU2/EPBU8)

## Installation Conditions

### Installation environment

- Installation this unit indoors.
- Do not install this unit in locations exposed to direct sunlight.
- Do not install this unit in locations in which there is corrosive gas or flammable gas.
- Do not install this unit in locations exposed to a lot of dust, soot, or stem.
- Do not install this unit in locations in which water, oil, or chemicals may splash onto the unit.
- When installing this unit in a location subject to vibration or impact, consider the vibration proof mounting.

### When installing this unit in a control console

- The ambient temperature for this unit should not exceed the upper temperature limit (refer to the derating characteristic). When the upper temperature limit may be exceeded, install a cooling fan or cooler so that the ambient temperature is below the upper temperature limit.
- Leave a sufficient ventilation space around this unit for head dissipation.
- Do not install this unit just above a device with high head generation (transformer, inverter, servo amplifier, etc.).

## Installation

### Space around the unit

The MS2 Series uses natural air-cooling. To ensure sufficient convection of air to dissipate heat, provide enough space between the MS2 Series and the control panel or other nearby devices as shown below.

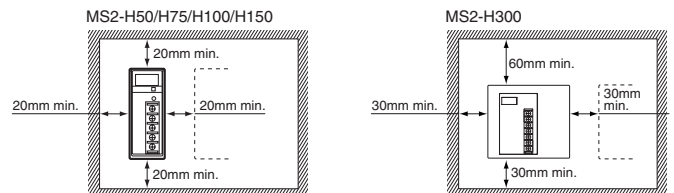

### Installation orientation

Install this unit with the base (A) down as shown below. Do not install the unit in any other orientation.

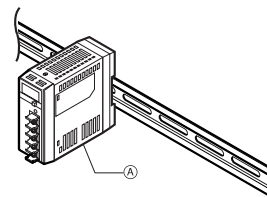

### Mounting bracket (optional)

Make sure that the tightening torque for the mounting screw holes of this unit is 0.5 N•m or less.

## Wiring

### Terminals

Screw size	Tightening torque
M4	1.2 N•m

### Crimp terminals



### Cables

Select cables with a wire diameter suited to the output rated current.



## Method of Operation

The display mode changes each time when the MODE switch is pressed.

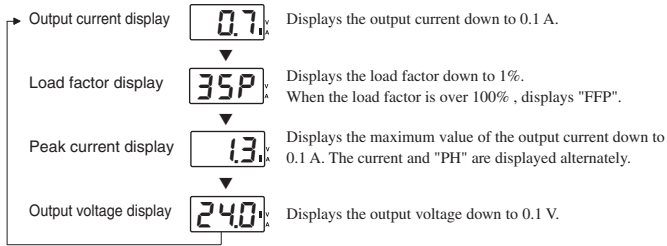

- The MS2 Series is set to the output current display mode before shipment. It retains the display mode that was used before the power was turned off.

- When the switch is held down for 3 seconds or more, the current mode is locked and cannot be changed. To unlock the mode, hold down the switch again for 3 seconds or more.

## Dimensions

Model	MS2-H50	MS2-H75	MS2-H100	MS2-H150	MS2-H300
Rated input voltage *1	100 to 240 VAC (85 to 264 VAC, 110 to 370 VDC)				
Rated Frequency *1	50/60 Hz (47 to 63 Hz, DC)				
Input current (100/200 VAC)	1.3 A/0.7 A max.	1.9 A/0.9 A max.	2.1 A/1.3A max.	2.2 A/1.1 A max.	3.9 A/1.8 A max.
Efficiency (100/200 VAC)	82%/35% typ. (with 100% load)				
Leakage current (100/200 VAC)	0.4 mA/0.75 mA max. (with 100% load)				
Rush current (100/200 VAC)	25 A/50 A max. (with 100% load, at 25°C cold start)				18 A/36 A max.
Rated output voltage	24 VDC				
Adjustable voltage range	±5% (with V.A.D.I.)				
Rated output current	2.1 A (Class2)	3.2 A	4.5 A	6.5 A	12.5 A
Ripple/noise voltage	180mVp-p max.				
Input fluctuation	0.4 % max.				
Load fluctuation	1.5 % max.				
Temperature fluctuation	0.02 %/°C max.				
Starting time	500 ms max. (at Surrounding Air Temperature of 0 to 55°C under rated I/O conditions)				
Output holding time	20 ms min. (at Surrounding Air Temperature of 25°C under rated I/O conditions)				
Overcurrent protection	Activates when the current reaches 125% or more of the rated output current. Constant current voltage limiting. Automatic reset.				
Overvoltage protection *2	Activates when the voltage reaches 26.4 V or more. Voltage turn-off. Operation resumes when the input power is turned on again.				
Display method	3-digit, 7-segment LED (Character height: 10 mm)				
Memory backup time	Approx. 10 years (at 20°C)				
Display resolution	0.1 A/0.1 V/1%				
Surrounding Air Temperature (for operation)	-10 to 55°C, No condensation (See "Output Derating Characteristics".)				
Relative humidity	25 to 85%, No condensation				
Surrounding Air Temperature (for storage)	-20 to 70°C, N. condensation				
Withstand voltage	3.0 kVAC 50/60 Hz 1 min (across input and output terminals), 2.0 kVAC 50/60 Hz 1min (across input terminals and PE terminal), 500 VAC 50/60 Hz 1 min (across output terminals and PE terminal)				
Shock	Peak acceleration: 300 m/s <sup>2</sup> , in X, Y, and Z directions, 2 times respectively				
Vibration	In X, Y, and Z directions, 2 hours respectively under the following conditions 10 to 57 Hz, 0.3 mm double-amplitude, 57 to 500 Hz, 19.6 m/s <sup>2</sup> (2G), 5.5-minute cycle				
Insulation resistance	100 MΩ min. (with 500 VDC megohmmeter) (across input and output terminals) (across input terminals and PE terminal) (across output terminals and PE terminal)				
Safety standard	UL : UL508, UL60950-1 C-UL : CSA C22.2 No.14-M95, CSA C22.2 No.60950-1-03 EN : EN60950-1, EN50178 IEC : IEC60950-1				
EMC standard	FCC Part15B ClassA, EN55011 ClassA, EN61000-6-2				
Limits for harmonic current emissions	EN61000-3-2 *3				
Parallel operation	Possible (OP-42207 is required.) *4				
Serial operation	Possible (External diode is required.) *4				

\*2 To reset the unit, turn off the input power once, wait for 1 minute or more, and then turn on the input power again.

\*3 For MS2-H100, it is applied only when the load ratio is 70% or lower.

\*4 The Applicable standards do not apply for parallel and serial operations.

## Output Derating Characteristics

MS2-H50/H150

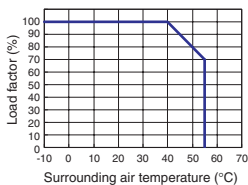

MS2-H75

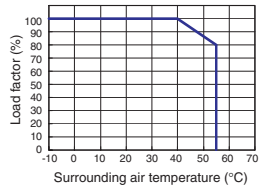

MS2-H100

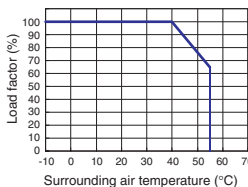

MS2-H300

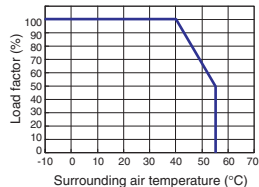

## Dimensions

MS2-H50/H150/H100

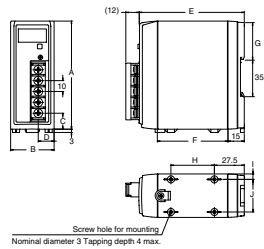

Model	A	B	C	D	E	F	G	H	I
MS2-H50	95.5	40	14.7	14.6	67	60	33.4	40	6
MS2-H75/H100	114.5	52	15.1	17.1	110	78	41	32	4.75

MS2-H300

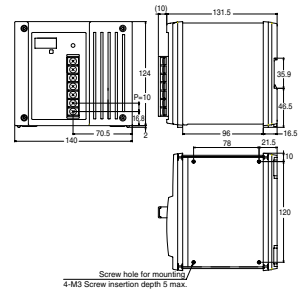

Model	A	B	C	D	E	F	G	H	I
MS2-H300	191.5	96	14	14	124	140	70.5	10	10

MS2-H150

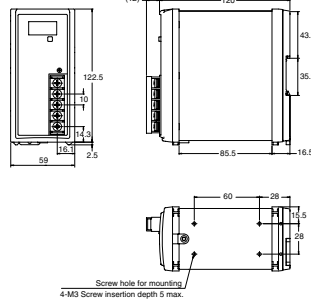

When bottom mounted

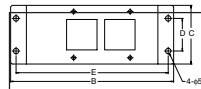
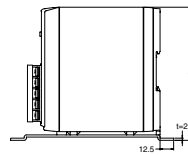

Mounting bracket	OP-51626	OP-51628	OP-42175
Matching model	MS2-H50	MS2-H75/H100	MS2-H150
A	107.5	122.5	132.8
B	158	150	160
C	45	54	55
D	20	35	43
E	125	140	150

When front mounted

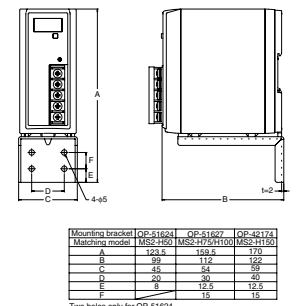

When side mounted

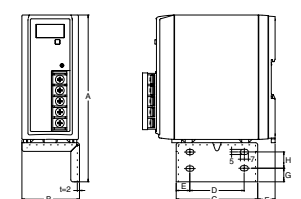

Mounting bracket	OP-51624	OP-51627	OP-51174
Matching model	MS2-H50	MS2-H75/H100	MS2-H150
A	124.5	153.5	170
B	89	112	122
C	45	54	55
D	20	30	40
E	6	12.5	12.5
F	6	15	15

Two holes only for OP-51624.

Mounting bracket	OP-51626	OP-51623
Matching model	MS2-H50	MS2-H75/H100/MS2-H150
A	120.5	131.8
B	65	62
C	45	55
D	20	25
E	12.5	12.5
F	14.5	20.9
G	6	12.5
H	6	15
I	6	15

Two holes only for OP-51626.  
The side mounting bracket can be attached to either sides.

**WARRANTIES (MUST ACCOMPANY THE PRODUCTS):** KEYENCE, at its sole option, will refund, repair or replace at no charge any defective Products within 1 year from the date of shipment. Unless stated otherwise herein, the Products should not be used internally in humans, for human transportation, as safety devices or fail-safe systems. EXCEPT FOR THE FOREGOING, ALL EXPRESS, IMPLIED AND STATUTORY

**WARRANTIES, INCLUDING WARRANTIES OF MERCHANTABILITY, FITNESS FOR A PARTICULAR PURPOSE AND NON-INFRINGEMENT OF PROPRIETARY RIGHTS, ARE EXPRESSLY DISCLAIMED.** KEYENCE SHALL NOT BE LIABLE FOR ANY DIRECT, INDIRECT, INCIDENTAL, CONSEQUENTIAL OR OTHER DAMAGES, EVEN IF DAMAGES RESULT FROM THE USE OF THE PRODUCTS IN ACCORDANCE WITH ANY SUGGESTIONS OR INFORMATION PROVIDED BY KEYENCE. In some jurisdictions, some of the foregoing warranty disclaimers or damage limitations may not apply.

# PLC Specifications

## General specifications

<b>Model</b>	AC type KV-10AT(P)/AR KV-16AT(P)/AR KV-24AT(P)/AR KV-40AT(P)/AR	DC type KV-10DT(P)/DR KV-16DT(P)/DR KV-24DT(P)/DR KV-40DT(P)/DR
<b>Rated voltage</b>	100 to 240 VAC (±10%)	24 VDC (+10%, -20%)
<b>AC current consumption</b>	KV-10AT(P)/AR: 0.4 A KV-16AT(P)/AR: 0.5 A KV-24AT(P)/AR: 0.6 A KV-40AT(P)/AR: 0.7 A	—
<b>AC power factor</b>	60%	—
<b>Output voltage</b>	24 VDC (±10%)	—
<b>Output capacity</b> <small>(Including the internal current consumption and current consumption of expansion units.)</small>	KV-10AT(P)/AR: 0.4 A KV-16AT(P)/AR: 0.6 A KV-24AT(P)/AR: 0.6 A KV-40AT(P)/AR: 0.7 A	—
<b>Allowable instantaneous interruption time</b>	40 ms max.	2 ms max.
<b>Internal current consumption (converted into 24 VDC value)</b>	KV-10AR/DR: 100 mA max. KV-10AT(P)/DT(P): 80(85) mA max. KV-16AR/DR: 120 mA max. KV-16AT(P)/DT(P): 90(100) mA max. KV-24AR/DR: 140 mA max. KV-24AT(P)/DT(P): 100(105) mA max. KV-40AR/DR: 180 mA max. KV-40AT(P)/DT(P): 120(130) mA max.	
<b>Expansion units</b>	KV-E8X: 25 mA max. KV-E16X: 35 mA max. KV-E8T(P): 40 mA max. KV-E16T(P): 60(70) mA max. KV-E8R: 70 mA max. KV-E16R: 110 mA max. KV-E4XR: 45 mA max. KV-E4XT(P): 30 mA max.	
	KV-D30 Operator interface panel: 60 mA max. KV-P3E Handheld programmer: 65 mA max.	
<b>Ambient temperature</b>	0 to 50°C, 0 to 45°C (KV-P3E)	
<b>Relative humidity</b>	35 to 85%	
<b>Ambient storage temperature</b>	-20 to +70°C	
<b>Withstand voltage</b>	1,500 VAC for 1 minute (Between power terminal and I/O terminals, and between external terminals and housing)	
<b>Noise immunity</b>	1,500 Vp-p min., pulse width: 1 μs, 50 ns (by noise simulator) Conforming to EN standard (EN61000-4-2/-3/-4/-6)	
<b>Shock</b>	150 m/s <sup>2</sup> (15 G), working time: 11 ms, in X, Y and Z directions, 2 times respectively	
<b>Vibration</b>	10 to 55 Hz, 1.5 mm max. double amplitude in X, Y and Z directions, 2 hours respectively (1 G max. when attached to DIN rail)	
<b>Insulation resistance</b>	50 MΩ min. (Between power terminal and I/O terminals, and between external terminals and housing, measured with 500 VDC megohmmeter)	
<b>Environmental restrictions</b>	No excessive dust or corrosive gases	
<b>Weight</b>	KV-10AR: Approx. 250 g, KV-10AT(P): Approx. 240 g, KV-16AR: Approx. 300 g, KV-16AT(P): Approx. 280 g, KV-24AR: Approx. 350 g, KV-24AT(P): Approx. 330 g, KV-40AR: Approx. 450 g, KV-40AT(P): Approx. 410 g, KV-10DR: Approx. 150 g, KV-10DT(P): Approx. 140 g, KV-16DR: Approx. 190 g, KV-16DT(P): Approx. 180 g, KV-24DR: Approx. 240 g, KV-24DT(P): Approx. 210 g, KV-40DR: Approx. 330 g, KV-40DT(P): Approx. 280 g	

## Performance specifications

<b>Arithmetic operation control method</b>	Stored program method				
<b>I/O control method</b>	Refresh method				
<b>Programming language</b>	Ladder diagram and expanded ladder diagram				
<b>Instruction types</b>	Basic instruction: 28, Application instruction: 22, Arithmetic instruction: 26, Interrupt instruction: 4				
<b>Minimum scan time</b>	140 μs min.				
<b>Instruction processing time</b>	Basic instruction: 0.7 μs min., Application instruction: 6.4 μs. min.				
<b>Program capacity</b>	2,000 steps (KV-10xx, KV-16xx) 4,000 steps (KV-24xx, KV-40xx)				
<b>Maximum number of expansion units</b>	8 (7 for KV-40xx)				
<b>Number of I/O points (including 10 to 40 I/O points of basic unit)</b>	10 to 152 points (when expansion units are connected)				
<b>Internal utility relay</b>	2,560 points: 1000 to 1915 and 3000 to 17915				
<b>Special utility relay</b>	160 points: 2000 to 2915				
<b>Data memory (16 bits)</b>	2,000 words: DM 0000 to DM1999				
<b>Temporary data memory (16 bits)</b>	32 words: TM00 to TM31				
<b>Timer/counter</b>	250 in all: 0.1-s timer: TMR (0 to 6553.5 s), 0.01-s timer: TMH (0 to 655.35 s), 0.001-s timer: TMS (0 to 65.535 s), UP counter: C, Up/down counter: UDC				
<b>Digital trimmer</b>	2 trimmers (set in access window)				
<b>High-speed counter</b>	2 counters of 30 kHz, 2-phase high-speed counter (0 to 65535 count) *1				
<b>High-speed counter comparator</b>	4 comparators (2 for each high-speed counter) Direct output allowed				
<b>Positioning control function</b>	Independent 1 axis, 50 kHz max.				
<b>Memory switch</b>	16				
<b>Memory backup</b>	<table border="0"> <tr> <td><b>Program memory</b></td> <td>Flash ROM, rewritable 100,000 times or more</td> </tr> <tr> <td><b>Data memory, counter, internal utility relay</b></td> <td>Data retained for 2 months min. with electrical double-layer capacitor (at 25°C), Data can be backed up with Flash ROM in all models.</td> </tr> </table> <small>(Retention devices are set by MEMSW instruction.)</small>	<b>Program memory</b>	Flash ROM, rewritable 100,000 times or more	<b>Data memory, counter, internal utility relay</b>	Data retained for 2 months min. with electrical double-layer capacitor (at 25°C), Data can be backed up with Flash ROM in all models.
<b>Program memory</b>	Flash ROM, rewritable 100,000 times or more				
<b>Data memory, counter, internal utility relay</b>	Data retained for 2 months min. with electrical double-layer capacitor (at 25°C), Data can be backed up with Flash ROM in all models.				
<b>Self-diagnosis</b>	CPU and RAM errors				
<b>Number of contact comments</b>	1,000 max. contact comments can be saved.				

\*1. 24-bit setting is available.



## Input/output circuit of base unit

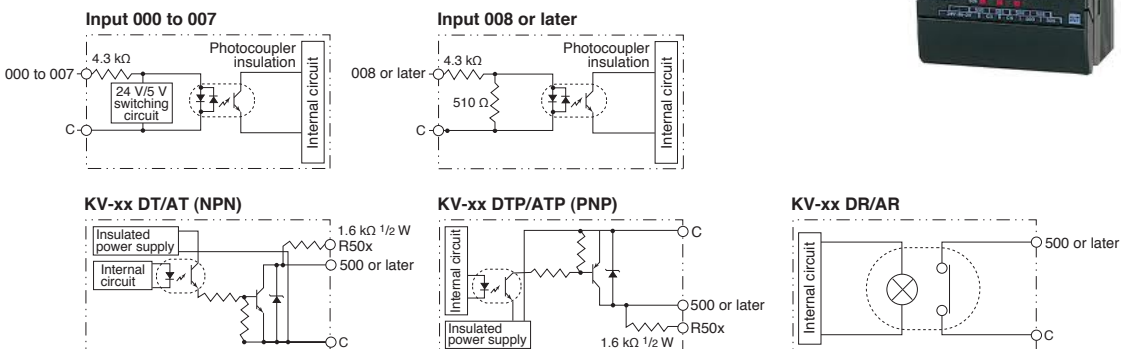

**Input specifications of base unit**

Model	KV-10xx	KV-16xx	KV-24xx	KV-40xx
No. of inputs	6	10	16	24
Input common	COM is connected internally.			
Maximum input rating	26.4 VDC			
Input voltage *1	24 VDC, 5.3 mA/5 VDC, 1.0 mA			
Input time constant	10 ms (Typical) 10 μs when HSP instruction is used Variable in 7 steps from 10 μs to 10 ms while special utility relay 2813 is ON (Set by DM1940)			
Interrupt input response	10 μs (Typical)			
High-speed counter input response	30 kHz (24V±10%)			

\*1. Inputs 000 to 007 can be changed to 5 V input.

**Output specifications of basic unit**

Model	KV-10xT(P)	KV-16xT(P)	KV-24xT(P)	KV-40xT(P)	KV-10xR	KV-16xR	KV-24xR	KV-40xR
No. of outputs	4	6	8	16	4	6	8	16
Output common	1 common				Each common terminal is independent.			
Output type	Transistor output (NPN or PNP)				Relay output			
Rated load	30 VDC 0.3 A (503 and other) 0.1 A (500 to 502)				250 VAC/30 VDC 2 A (Inductive load) 4 A (Resistive load)			
Peak load current	0.2 A (500 to 502) 1 A (Other)				5 A			
Relay service life	—				Electrical service life: 100,000 times or more (20 times/min) Mechanical service life: 20-million times or more			
Relay replacement	—				Not allowed			
Output frequency	50 kHz (500 to 502)				—			
Built-in serial resistance	1.6 kΩ 1/2W (R500 to R502)				—			

**Input/output specifications of expansion unit**

Input/output	Input		Output				Input/output
External connection method	Terminal block						
Model	KV-E8X	KV-E16X	KV-E8T(P)	KV-E16T(P)	KV-E8R	KV-E16R	KV-E4XT(P)/R
Number of inputs	8	16	—		—		4
Input common	4 points/common		—				4 points/common
Maximum input rating	26.4 VDC		—				26.4 VDC
Input voltage	24 VDC, 5.3 mA		—				24 VDC, 5.3 mA
Minimum ON voltage	19 V		—				19 V
Maximum OFF current	2 mA		—				2 mA
Input impedance	4.3 kΩ		—				4.3 kΩ
Input time constant <small>(Changed in two steps by special utility relays 2809 to 2812)</small>	For both rising (OFF → ON) and falling (ON → OFF) operations, 10 ms: 10 ms±20%, 10 μs: 10 μs±20%		—				For both rising (OFF → ON) and falling (ON → OFF) operations, 10 ms: 10 ms±20%, 10 μs: 10 μs±20%
Number of outputs	—		8	16	8	16	4
Output type	—		NPN (PNP) Transistor		Relay		NPN (PNP) Transistor/Relay
Output common	—		COM is connected internally.		4 points/common		4 points/common
Rated load voltage	—		30 VDC		250 VAC/30 VDC, 2 A (Inductive load), 4 A (Resistive load)		30 VDC/, 250 VAC/30 VDC, 2 A (Inductive load), 4 A (Resistive load)
Rated output current	—		0.5 (0.3) A/point		2 A/point (Inductive load), 4 A/point (Resistive load), 4 A/common		0.5 A/point/, 2 A/point (Inductive load), 4 A (Resistive load), 4 A/common
ON resistance	—		—		50 mΩ or less		— / 50 mΩ or less
Leakage current at OFF	—		100 μA max.		—		100 μA max./ —
Residual voltage at ON	—		0.8 V max.		—		0.8 V max./ —
Rising operation time (OFF → ON)	—		50 μs max.		10 ms max.		50 μs max./10 ms max.
Falling operation time (ON → OFF)	—		250 μs max.		10 ms max.		250 μs max./10 ms max.
Relay service life	—		—		Electrical: 100,000 times or more (20 times/min), Mechanical: 20-million times or more		Electrical: 100,000 times or more (20 times/min), Mechanical: 20-million times or more
Relay replacement	—		—		Not allowed		— /Not allowed
Weight	Approx. 100 g	Approx. 130 g	Approx. 100 g	Approx. 130 g	Approx. 130 g	Approx. 190 g	Approx. 100 g/Approx. 120 g

**Input/output circuit of expansion unit**

